

# YAMAHA

# R-V702

# R-V502

*Natural Sound AV Receiver*

*Récepteur audiovisuel "Son Naturel"*

*Receptor AV de Sonido Natural*

*Thank you for selecting this YAMAHA AV receiver.*

*Nous vous remercions d'avoir porté votre choix sur ce récepteur audiovisuel YAMAHA.*

*Muchas gracias por haber adquirido este receptor AV YAMAHA.*

**OWNER'S MANUAL  
MODE D'EMPLOI  
MANUAL DE INSTRUCCIONES**

# SAFETY INSTRUCTIONS

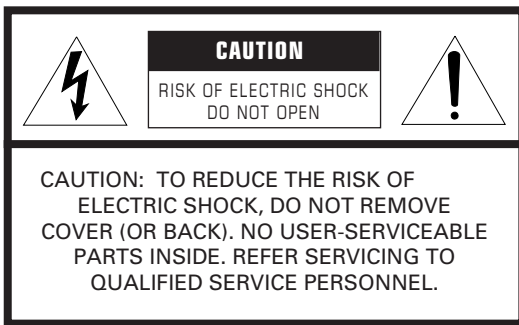

• Explanation of Graphical Symbols

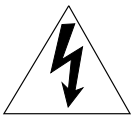

The lightning flash with arrowhead symbol, within an equilateral triangle, is intended to alert you to the presence of uninsulated "dangerous voltage" within the product's enclosure that may be of sufficient magnitude to constitute a risk of electric shock to persons.



The exclamation point within an equilateral triangle is intended to alert you to the presence of important operating and maintenance (servicing) instructions in the literature accompanying the appliance.

**WARNING**

**TO REDUCE THE RISK OF FIRE OR ELECTRIC SHOCK, DO NOT EXPOSE THIS UNIT TO RAIN OR MOISTURE.**

- 1 Read Instructions – All the safety and operating instructions should be read before the unit is operated.
- 2 Retain Instructions – The safety and operating instructions should be retained for future reference.
- 3 Heed Warnings – All warnings on the unit and in the operating instructions should be adhered to.
- 4 Follow Instructions – All operating and other instructions should be followed.
- 5 Water and Moisture – The unit should not be used near water – for example, near a bathtub, washbowl, kitchen sink, laundry tub, in a wet basement, or near a swimming pool, etc.
- 6 Carts and Stands – The unit should be used only with a cart or stand that is recommended by the manufacturer.
- 6A A unit and cart combination should be moved with care. Quick stops, excessive force, and uneven surfaces may cause the unit and cart combination to overturn.
- 7 Wall or Ceiling Mounting – The unit should be mounted to a wall or ceiling only as recommended by the manufacturer.
- 8 Ventilation – The unit should be situated so that its location or position does not interfere with its proper ventilation. For example, the unit should not be situated on a bed, sofa, rug, or similar surface, that may block the ventilation openings; or placed in a built-in installation, such as a bookcase or cabinet that may impede the flow of air through the ventilation openings.
- 9 Heat – The unit should be situated away from heat sources such as radiators, stoves, or other appliances that produce heat.
- 10 Power Sources – The unit should be connected to a power supply only of the type described in the operating instructions or as marked on the unit.
- 11 Power-Cord Protection – Power-supply cords should be routed so that they are not likely to be walked on or pinched by items placed upon or against them, paying particular attention to cords at plugs, convenience receptacles, and the point where they exit from the unit.
- 12 Cleaning – The unit should be cleaned only as recommended by the manufacturer.
- 13 Nonuse Periods – The power cord of the unit should be unplugged from the outlet when left unused for a long period of time.
- 14 Object and Liquid Entry – Care should be taken so that objects do not fall into and liquids are not spilled into the inside of the unit.
- 15 Damage Requiring Service – The unit should be serviced by qualified service personnel when:
  - A. The power-supply cord or the plug has been damaged; or
  - B. Objects have fallen, or liquid has been spilled into the unit; or
  - C. The unit has been exposed to rain; or
  - D. The unit does not appear to operate normally or exhibits a marked change in performance; or
  - E. The unit has been dropped, or the cabinet damaged.
- 16 Servicing – The user should not attempt to service the unit beyond those means described in the operating instructions. All other servicing should be referred to qualified service personnel.
- 17 Power Lines – An outdoor antenna should be located away from power lines.
- 18 Grounding or Polarization – Precautions should be taken so that the grounding or polarization is not defeated.



**19 For US customers only:**

**Outdoor Antenna Grounding** – If an outside antenna is connected to this unit, be sure the antenna system is grounded so as to provide some protection against voltage surges and built-up static charges. Article 810 of the National Electrical Code, ANSI/NFPA 70, provides information with regard to proper grounding of the mast and supporting structure, grounding of the lead-in wire to an antenna discharge unit, size of grounding conductors, location of antenna discharge unit, connection to grounding electrodes, and requirements for the grounding electrode.

**Note to CATV system installer:**

This reminder is provided to call the CATV system installer's attention to Article 820-40 of the NEC that provides guidelines for proper grounding and, in particular, specifies that the cable ground shall be connected to the grounding system of the building, as close to the point of cable entry as practical.

**SPECIAL NOTES FOR FCC COMPOSITE DEVICE (for US customers only)**

This device is a composite system. The digital device component may not cause harmful interference.

EXAMPLE OF ANTENNA GROUNDING

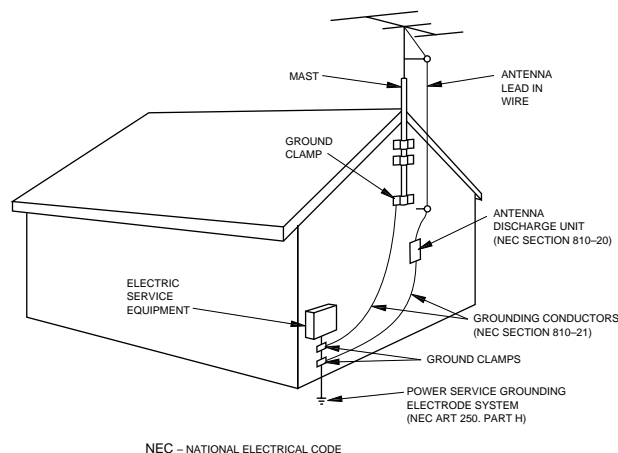
**FCC INFORMATION (for US customers only)****1. IMPORTANT NOTICE : DO NOT MODIFY THIS UNIT!**

This product, when installed as indicated in the instructions contained in this manual, meets FCC requirements. Modifications not expressly approved by Yamaha may void your authority, granted by the FCC, to use the product.

**2. IMPORTANT :** When connecting this product to accessories and/or another product use only high quality shielded cables. Cable/s supplied with this product **MUST** be used. Follow all installation instructions. Failure to follow instructions could void your FCC authorization to use this product in the USA.**3. NOTE :** This product has been tested and found to comply with the requirements listed in FCC Regulations, Part 15 for Class "B" digital devices. Compliance with these requirements provides a reasonable level of assurance that your use of this product in a residential environment will not result in harmful interference with other electronic devices.

This equipment generates/uses radio frequencies and, if not installed and used according to the instructions found in the users manual, may cause interference harmful to the operation of other electronic devices.

Compliance with FCC regulations does not guarantee that interference will not occur in all installations. If this product is found to be the source of interference, which can be determined by turning the unit "OFF" and "ON", please try to eliminate the problem by using one of the following measures:

Relocate either this product or the device that is being affected by the interference.

Utilize power outlets that are on different branch (circuit breaker or fuse) circuits or install AC line filter/s.

In the case of radio or TV interference, relocate/reorient the antenna. If the antenna lead-in is 300 ohm ribbon lead, change the lead-in to coaxial type cable.

If these corrective measures do not produce satisfactory results, please contact the local retailer authorized to distribute this type of product. If you can not locate the appropriate retailer, please contact Yamaha Electronics Corp., U.S.A. 6660 Orangethorpe Ave, Buena Park, CA 90620.

The above statements apply **ONLY** to those products distributed by Yamaha Corporation of America or its subsidiaries.

**We Want You Listening For A Lifetime (for US customers only)**

YAMAHA and the Electronic Industries Association's Consumer Electronics Group want you to get the most out of your equipment by playing it at a safe level. One that lets the sound come through loud and clear without annoying blaring or distortion – and, most importantly, without affecting your sensitive hearing.

Since hearing damage from loud sounds is often undetectable until it is too late, YAMAHA and the Electronic Industries Association's Consumer Electronics Group recommend you to avoid prolonged exposure from excessive volume levels.



# CONTENTS

Safety Instructions .....	Inside the Front Cover	Speaker Balance Adjustment .....	20
Supplied Accessories .....	2	Basic Operations .....	23
Features .....	3	Tuning Operations .....	26
Caution .....	4	Preset Tuning .....	27
Notes about the Remote Control Transmitter .....	5	Using Digital Sound Field Processor (DSP) .....	30
Profile of This Unit .....	6	Setting the SLEEP Timer .....	34
Speaker Setup .....	7	Troubleshooting .....	35
Connections .....	8	Specifications .....	36
Controls and Their Functions .....	14		

# SUPPLIED ACCESSORIES

After unpacking, check that the following parts are included.

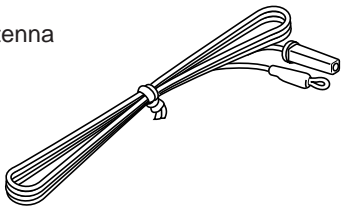
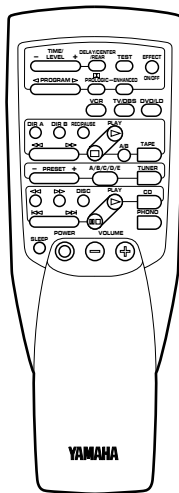
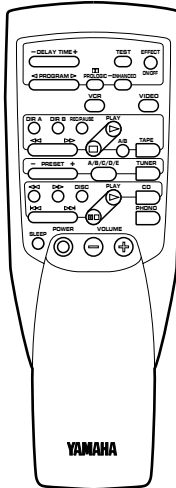
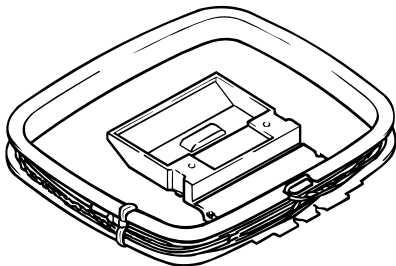
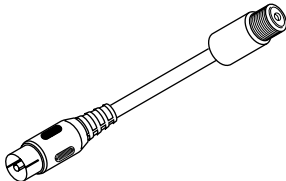
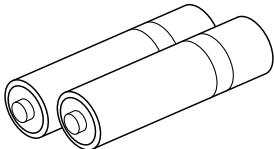
<p>Indoor FM Antenna</p> 	<p>Remote Control Transmitter</p> <div style="display: flex; justify-content: space-around; align-items: center;"> <div style="text-align: center;"> <p><b>R-V702</b></p>  </div> <div style="text-align: center;"> <p><b>R-V502</b></p>  </div> </div>
<p>AM Loop Antenna</p> 	
<p>Antenna adapter (U.S.A. and Canada models only)</p> 	
<p>Batteries (size AA, R6, UM-3)</p> 	

## FEATURES

---

### ● 5 Speaker Configuration

#### **R-V702**

##### <U.S.A. and Canada models>

**Main:** 80W + 80W (8Ω) RMS Output Power, 0.09% THD, 1 kHz

**Center:** 80W (8Ω) RMS Output Power, 0.09% THD, 1 kHz

**Rear:** 20W + 20W (8Ω) RMS Output Power, 0.7% THD, 1 kHz

##### <Australia and General models>

**Main:** 80W + 80W (8Ω) RMS Output Power, 0.09% THD, 1 kHz

**Center:** 80W (8Ω) RMS Output Power, 0.09% THD, 1 kHz

**Rear:** 20W + 20W (8Ω) RMS Output Power, 0.7% THD, 1 kHz

#### **R-V502**

##### <U.S.A. model>

**Main:** 70W + 70W (8Ω) RMS Output Power, 0.09% THD, 1 kHz

**Center:** 70W (8Ω) RMS Output Power, 0.09% THD, 1 kHz

**Rear:** 20W + 20W (8Ω) RMS Output Power, 0.7% THD, 1 kHz

##### <Australia, Canada and General models>

**Main:** 60W + 60W (8Ω) RMS Output Power, 0.09% THD, 1 kHz

**Center:** 60W (8Ω) RMS Output Power, 0.09% THD, 1 kHz

**Rear:** 20W + 20W (8Ω) RMS Output Power, 0.7% THD, 1 kHz

- Digital Sound Field Processor
- Dolby Pro Logic Surround Decoder
- Theater-like Sound Experience by the Combination of Dolby Pro Logic and YAMAHA DSP Technology (CINEMA DSP)
- Automatic Input Balance Control for Dolby Pro Logic Surround
- Test Tone Generator for Easier Speaker Balance Adjustment
- 3 Center Channel Modes (NORMAL/WIDE/PHANTOM)
- 40-Station Random Access Preset Tuning
- Automatic Preset Tuning
- Preset Station Shifting Capability (Preset Editing)
- IF Count Direct PLL Synthesizer Tuning System
- Video Signal Input/Output Capability
- SLEEP Timer
- Remote Control Capability

## CAUTION : READ THIS BEFORE OPERATING YOUR UNIT.

1. To assure the finest performance, please read this manual carefully. Keep it in a safe place for future reference.
2. Install this unit in a cool, dry, clean place – away from windows, heat sources, sources of excessive vibration, dust, moisture and cold. Avoid sources of humming (transformers, motors). To prevent fire or electrical shock, do not expose the unit to rain or water.
3. Never open the cabinet. If something drops into the set, contact your dealer.
4. Do not use force on switches, controls or connection wires. When moving the unit, first disconnect the power plug and the wires connected to other equipment. Never pull the wires themselves.
5. The openings on the cabinet assure proper ventilation of the unit. If these openings are obstructed, the temperature inside the cabinet will rise rapidly. Therefore, avoid placing objects against these openings, and install the unit in well-ventilated condition. Make sure to allow a space of at least 10 cm behind, 20 cm on the both sides and 30 cm above the top panel of the unit. Otherwise it may not only damage the unit, but also cause fire.
6. Always set the VOLUME control to “– ∞” before starting the audio source play. Increase the volume gradually to an appropriate level after playback has been started.
7. Do not attempt to clean the unit with chemical solvents; this might damage the finish. Use a clean, dry cloth.
8. Be sure to read the “TROUBLESHOOTING” section regarding common operating errors before concluding that the unit is faulty.
9. When not planning to use this unit for long periods of time (ie., vacation, etc.), disconnect the AC power plug from the wall outlet.
10. To prevent lightning damage, disconnect the AC power plug and disconnect the antenna cable when there is an electrical storm.
11. Grounding or polarization – Precautions should be taken so that the grounding or polarization of an appliance is not defeated.
12. AC outlet  
Do not connect audio equipment to the AC outlet on the rear panel if that equipment requires more power than the outlet is rated to provide.
13. **Voltage Selector (General Model only)**  
**The voltage selector on the rear panel of this unit must be set for your local main voltage BEFORE plugging into the AC main supply.**  
**Voltages are 110/120/220/240 V AC, 50/60 Hz.**

### IMPORTANT

Please record the serial number of this unit in the space below.

Serial No.:

The serial number is located on the rear of the unit. Retain this Owner's Manual in a safe place for future reference.

### WARNING

TO REDUCE THE RISK OF FIRE OR ELECTRIC SHOCK, DO NOT EXPOSE THIS UNIT TO RAIN OR MOISTURE.

### FOR CANADIAN CUSTOMERS

TO PREVENT ELECTRIC SHOCK, MATCH WIDE BLADE OF PLUG TO WIDE SLOT AND FULLY INSERT.

THIS CLASS B DIGITAL APPARATUS MEETS ALL REQUIREMENTS OF THE CANADIAN INTERFERENCE-CAUSING EQUIPMENT REGULATIONS.

The apparatus is not disconnected from the AC power source as long as it is connected to the wall outlet, even if the apparatus itself is turned off.

### FREQUENCY STEP switch (General Model only)

Because the interstation frequency spacing differs in different areas, set the FREQUENCY STEP switch (located at the rear) according to the frequency spacing in your area. Before setting this switch, disconnect the AC power plug of this unit from the AC outlet.

# NOTES ABOUT THE REMOTE CONTROL TRANSMITTER

## Battery installation

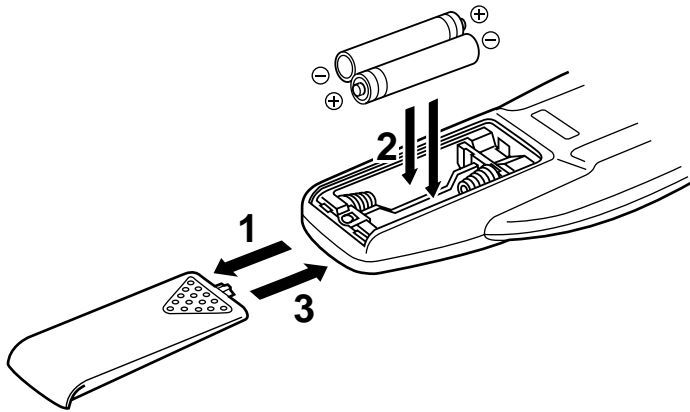

## Remote control transmitter operation range

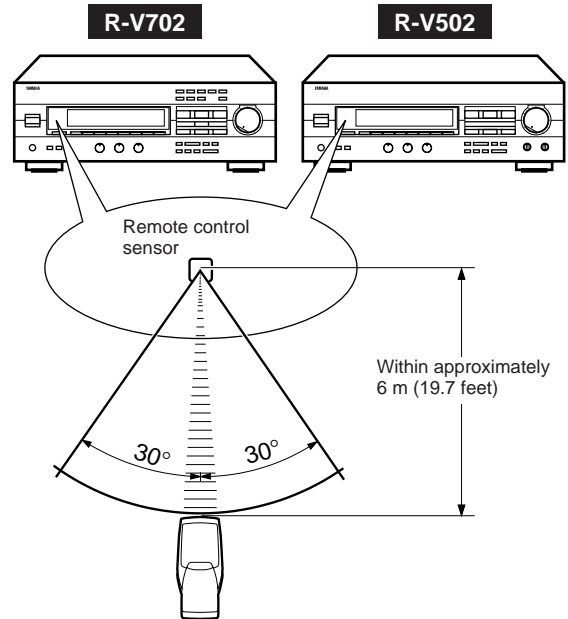

## Battery replacement

If you find that the remote control transmitter must be used closer to the main unit, the batteries are weak. Replace both batteries with new ones.

### Notes

- Use only AA, R6, UM-3 batteries for replacement.
- Be sure the polarities are correct. (See the illustration inside the battery compartment.)
- Remove the batteries if the remote control transmitter will not be used for an extended period of time.
- If batteries leak, dispose of them immediately. Avoid touching the leaked material or letting it come in contact with clothing, etc. Clean the battery compartment thoroughly before installing new batteries.

### Notes

- There should be no large obstacles between the remote control transmitter and the main unit.
- If the remote control sensor is directly illuminated by strong lighting (especially an inverter type of fluorescent lamp etc.), it might cause the remote control transmitter not to work correctly. In this case, reposition the main unit to avoid direct lighting.

# PROFILE OF THIS UNIT

You are the proud owner of a Yamaha stereo receiver –an extremely sophisticated audio component. The Digital Sound Field Processor (DSP) built into this unit takes advantage of Yamaha's undisputed leadership in the field of digital audio processing to bring you a whole new world of listening experiences. Follow the instructions in this manual carefully when setting up your system, and this unit will sonically transform your room into a wide range of listening environments –movie theater, concert hall, and so on. In addition, you get incredible realism from sources encoded with Dolby Surround using the built-in Dolby Pro Logic Surround Decoder.

Please read this operation manual carefully and store it in a safe place for later reference.

## Digital Sound Field Processing

---

What is it that makes live music so good? Today's advanced sound reproduction technology lets you get extremely close to the sound of a live performance, but chances are you'll still notice something missing: the acoustic environment of the live concert hall. Extensive research into the exact nature of the sonic reflections that create the ambience of a large hall has made it possible for Yamaha engineers to bring you this same sound in your own listening room, so you'll feel all the sound of a live concert.

Furthermore, our technicians, armed with sophisticated measuring equipment, have even made it possible to capture the acoustics of a variety of venues such as an actual concert hall, theater, etc. to allow you to accurately recreate one of several actual live performance environments, all in your own home.

## Dolby Pro Logic Surround

---

This unit employs a Dolby Pro Logic Surround decoder similar to professional Dolby Stereo decoders used in many movie theaters. By using the Dolby Pro Logic Surround decoder, you can experience the dramatic realism and impact of Dolby Surround movie theater sound in your own home. Dolby Pro Logic employs a four channel five speaker system. The Pro Logic Surround system divides the input signal into four levels: the left and right main channels, the center channel (used for dialog), and the rear surround sound channels (used for sound effects, background noise, and other ambient noises). The center channel allows listeners seated in even less-than-ideal positions to hear the dialog originating from the action on the screen while experiencing good stereo imaging. Dolby Surround is encoded on the sound track of pre-recorded video tapes, laser discs, and some TV/cable broadcasts. When you play a source encoded with Dolby Surround on this unit, the Dolby Pro Logic Surround decoder decodes the signal and distributes the surround-sound effects.

This Dolby Pro Logic Surround Decoder employs a digital signal processing system. This system improves the stability of sound at each channel and minimizes crosstalk between channels, so that positioning of sounds around the room is more accurate compared with conventional analog signal processing systems. In addition, this unit features a built-in automatic input balance control. This always assures you the best performance without manual adjustment.

Manufactured under license from Dolby Laboratories Licensing Corporation. "Dolby", the double-D symbol and "Pro Logic" are trademarks of Dolby Laboratories Licensing Corporation.

## Dolby Pro Logic Surround + DSP

---

Dolby Surround sound system shows its full ability in a large movie theater, because movie sounds are originally designed to be reproduced in a large movie theater using many speakers. It is difficult to create a sound environment similar to that of a movie theater in your listening room, because the room size, materials of inside walls, the number of speakers, etc. of your listening room is much different from those of a movie theater.

Yamaha DSP technology made it possible to present you with nearly the same sound experience as that of a large movie theater in your listening room by compensating for lack of presence and dynamics in your listening room with its original digital sound fields combined with Dolby Surround sound field.

The combination of Dolby Pro Logic Surround and DSP is used on the sound field program "  PRO LOGIC ENHANCED".

### **CINEMA DSP**

The YAMAHA "CINEMA DSP" logo indicates these programs are created by the combination of Dolby Pro Logic and YAMAHA DSP technology.



# SPEAKER SETUP

## SPEAKERS TO BE USED

This unit is designed to provide the best sound-field quality with a 5 speaker configuration. The most effective speakers to use with this unit are main speakers, rear speakers and a center speaker. You may omit the center speaker. (Refer to the “**4-Speaker Configuration**” shown below.)

The main speakers are used for the main source sound plus the effect sounds. They will probably be the speakers from your present stereo system. The rear speakers are used for the effect and surround sounds, and the center speaker is for the center sounds (dialog etc.) within programs encoded with Dolby Surround. The center speaker needs to be equal in power to the main speakers, although the rear speakers should not be equal. However, all the speakers should have high enough power handling to accept the maximum output of this unit.

## SPEAKER CONFIGURATION

### 5-Speaker Configuration

This configuration is the most effective and recommended one. In this configuration, the center speaker is necessary as well as the rear speakers. If the program **DOLBY PRO LOGIC** or **DOLBY PRO LOGIC ENHANCED** is selected, conversations will be output from the center speaker and the ambience will be excellent.

- Set the center channel mode to the “**NORMAL**” or “**WIDE**” position. (For details, refer to page 21.)

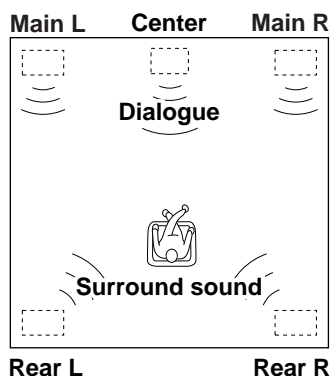

### 4-Speaker Configuration

The center speaker is not used in this configuration. If the program **DOLBY PRO LOGIC** or **DOLBY PRO LOGIC ENHANCED** is selected, the center sound is output from the left and the right main speakers. However, the sound effect of other programs can be the same as that of the 5-speaker configuration.

- Be sure to set the center channel mode to the “**PHANTOM**” position. (For details, refer to page 21.)

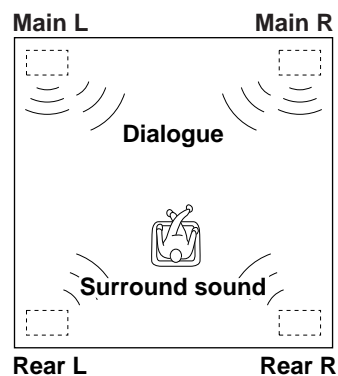

## SPEAKER PLACEMENT

The recommended speaker configuration, the 5-speaker configuration, will require two speaker pairs: **main speakers** (your normal stereo speakers), and **rear speakers**, plus a **center speaker**. When you place these speakers, refer to the following.

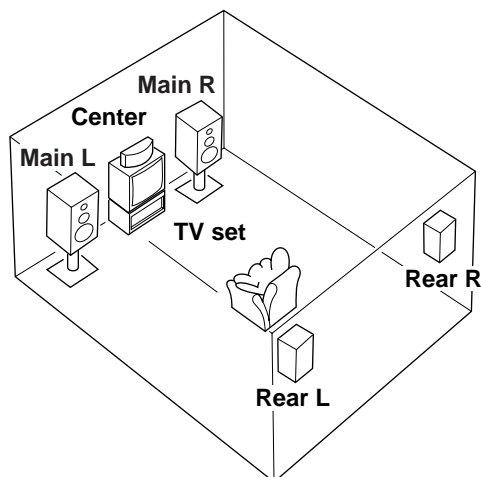

- Main:** In normal position. (The position of your present stereo speaker system.)
- Rear:** Behind your listening position, facing slightly inward. Nearly six feet (approx. 1.8 m) up from the floor.
- Center:** Precisely between the main speakers. (To avoid interference with TV sets, use a magnetically shielded speaker.)

# CONNECTIONS

Never plug in this unit and other components until all connections are completed.

## CONNECTIONS WITH OTHER COMPONENTS

When making connections between this unit and other components, be sure all connections are made correctly, that is to say L (left) to L, R (right) to R, “+” to “+” and “-” to “-”. Also, refer to the owner’s manual for each component to be connected to this unit.

\* If you have YAMAHA components numbered as 1, 2, 3, etc. on the rear panel, connections can be made easily by making sure to connect the output (or input) terminals of each component to the same-numbered terminals of this unit.

### R-V702

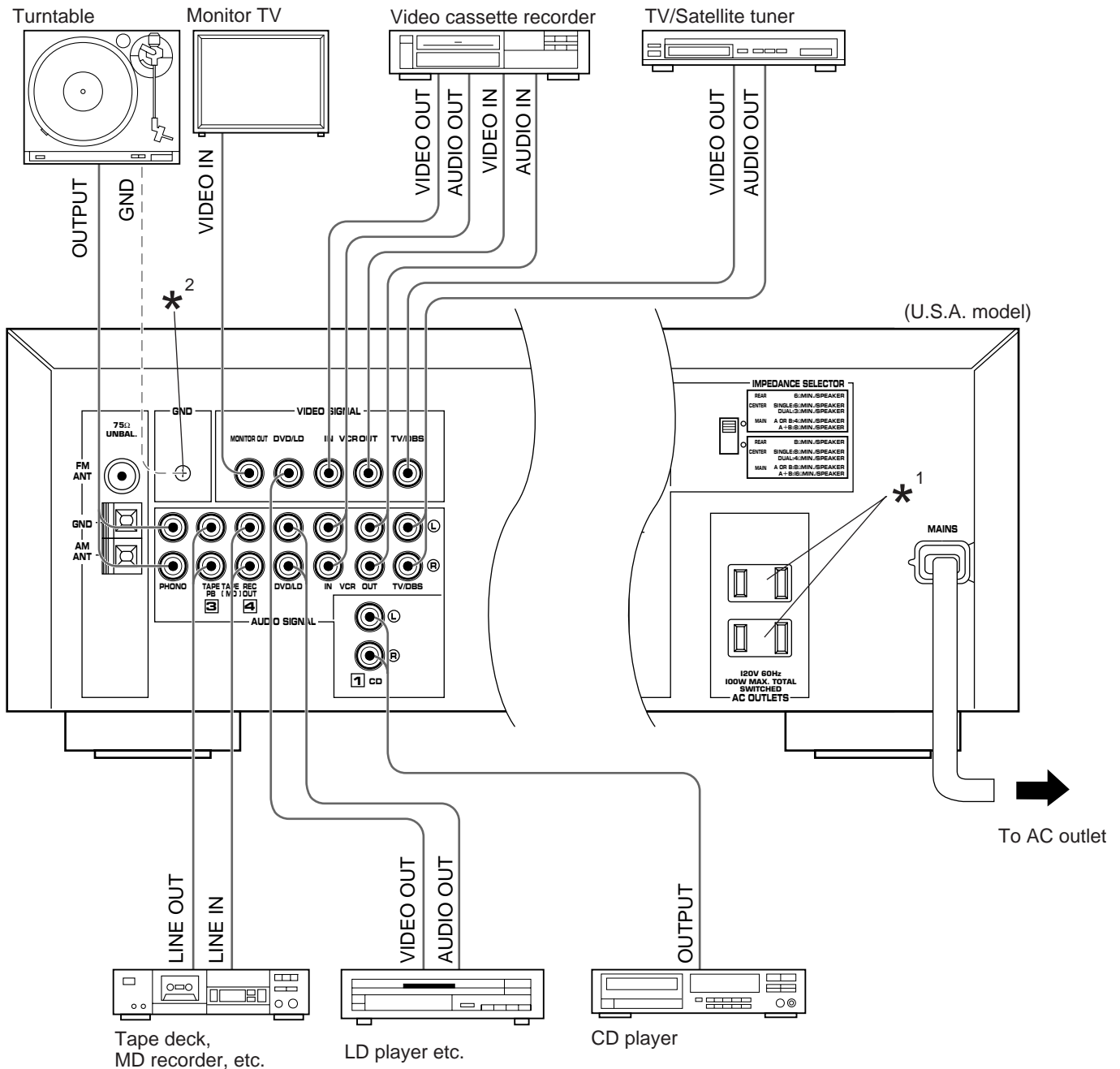

\*<sup>1</sup>, \*<sup>2</sup>: See the next page.

**R-V502**

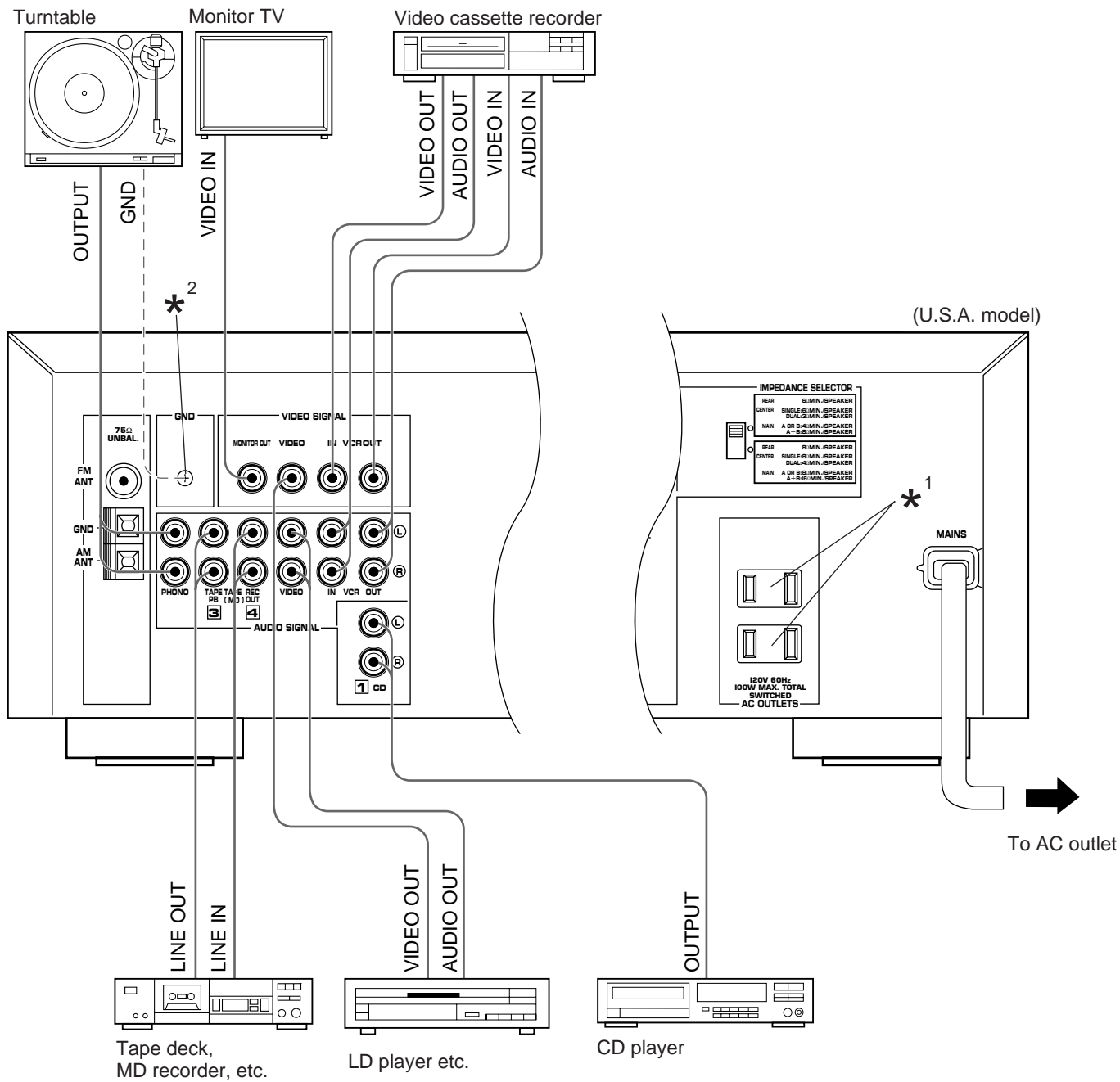

**\*<sup>1</sup>**  
**AC OUTLET(S) (SWITCHED)**  
 (U.S.A., Canada and General models) ..... 2 SWITCHED OUTLETS  
 (Australia model) ..... 1 SWITCHED OUTLET

Use these to connect the power cords from your components to this unit.

The power to the **SWITCHED** outlets is controlled by this unit's **POWER** switch or the provided remote control transmitter's **POWER** key. These outlets will supply power to any component whenever this unit is turned on.

The maximum power (total power consumption of components) that can be connected to the **SWITCHED AC OUTLET(S)** is 100 watts.

**\*<sup>2</sup>**  
**GND terminal (For turntable use)**

Connecting the ground wire of the turntable to the **GND** terminal will normally minimize hum, but in some cases better results may be obtained with the ground wire disconnected.

# CONNECTING SPEAKERS

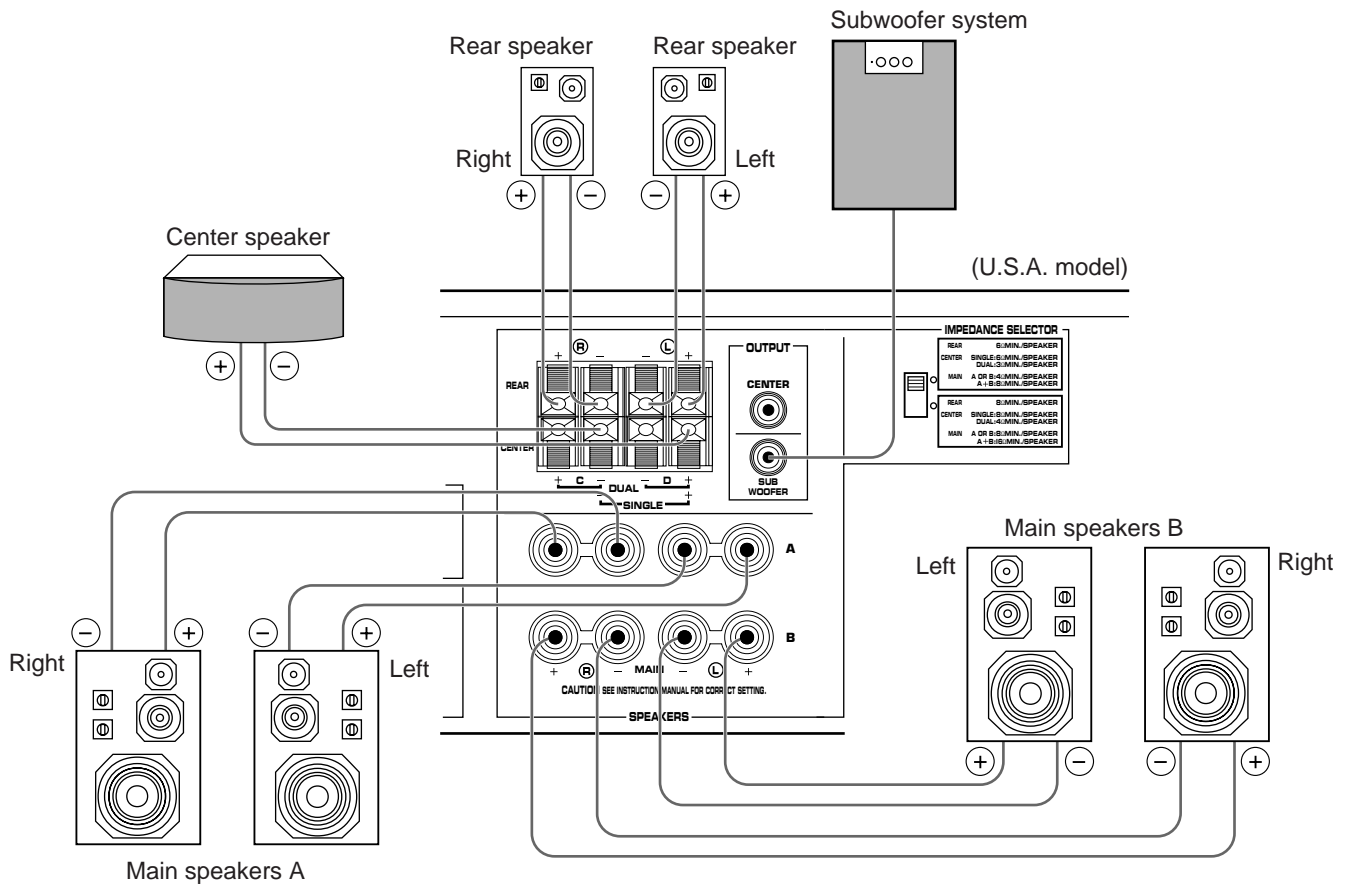

**Note**

Use speakers with the specified impedance shown on the rear of this unit.

**Note on main speaker connections:**

One or two speaker systems can be connected to this unit. If you use only one speaker system, connect it to either the **SPEAKERS A** or **B** terminals.

**Note on a subwoofer connection:**

You may wish to add a subwoofer to reinforce low frequencies. Connect the **SUBWOOFER OUTPUT** terminal of this unit to the **INPUT** terminal of the subwoofer amplifier, and connect the speaker terminals of the subwoofer amplifier to the subwoofer. With some subwoofers, including the Yamaha Active Servo Processing Subwoofer System, the amplifier and subwoofer are in the same unit.

**Note on center speaker connection:**

One or two center speakers can be connected to this unit. If you cannot place the center speaker on or under the TV, it is recommended to use two center speakers and place them on both sides of the TV to orient the center sound at the center position. For connecting two center speakers, follow the method shown below.

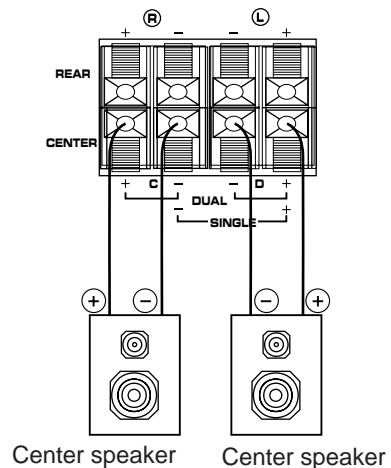

## How to Connect:

Connect the **SPEAKERS** terminals to your speakers with wire of the proper gauge, cut as short as possible. If the connections are faulty, no sound will be heard from the speakers. Make sure that the polarity of the speaker wires is correct, that is the + and – markings are observed. If these wires are reversed, the sound will be unnatural and lack bass.

### Caution

**Do not let the bare speaker wires touch each other and do not let them touch any metal part of this unit. This could damage this unit and/or speakers.**

#### For connecting to the MAIN SPEAKERS terminals

Red: positive (+)  
Black: negative (-)

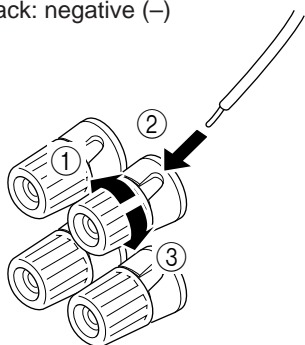

- ① Unscrew the knob.
- ② Insert the bare wire.  
[Remove approx. 5mm (1/4") insulation from the speaker wires.]
- ③ Tighten the knob and secure the wire.

#### For connecting to the REAR and CENTER SPEAKERS terminals

Red: positive (+)  
Black: negative (-)

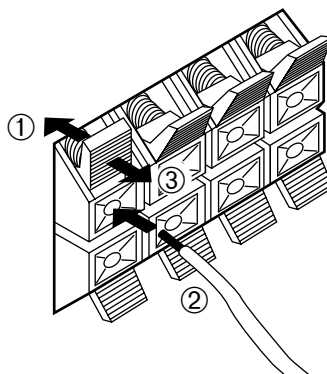

- ① Press the tab.
- ② Insert the bare wire.  
[Remove approx. 5mm (1/4") insulation from the speaker wires.]
- ③ Release the tab and secure the wire.

Banana Plug connections are also possible. Simply insert the Banana Plug connector into the corresponding terminal.

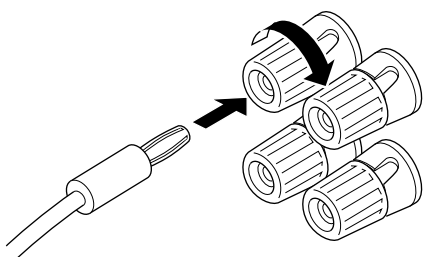

## OUTPUT terminals (for driving speakers with external amplifiers)

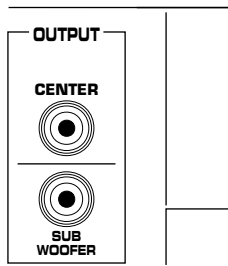

### CENTER OUTPUT terminal

This terminal is for center channel line output. There is no connection to this terminal when you use the built-in amplifier. However, if you drive a center speaker with an external power amplifier, connect the input terminal of the external amplifier to this terminal.

### SUBWOOFER OUTPUT terminal

This terminal is for connecting with the input terminal of an amplifier for driving a subwoofer.

This terminal outputs only frequencies below 200 Hz from the main and center channels.

#### Note

Output level of signals from these terminals are adjusted by the use of **VOLUME** control on the front panel or **VOLUME** keys on the remote control transmitter.

## IMPEDANCE SELECTOR switch

Be sure to switch this only when the power of this unit is turned off.

Select the position whose requirements your speaker system meets.

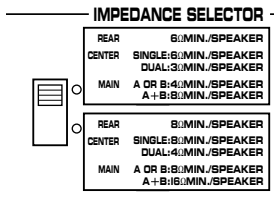

(U.S.A. model)

 (Upper position)

**Rear:** The impedance of each speaker must be 6Ω or higher.

**Center:** If you use one center speaker, the impedance of the speaker must be 6Ω or higher.  
If you use two center speakers, the impedance of each speaker must be 3Ω or higher.

**Main:** If you use one pair of main speakers, the impedance of each speaker must be 4Ω or higher.  
If you use two pairs of main speakers, the impedance of each speaker must be 8Ω or higher.

 (Lower position)

**Rear:** The impedance of each speaker must be 8Ω or higher.

**Center:** If you use one center speaker, the impedance of the speaker must be 8Ω or higher.  
If you use two center speakers, the impedance of each speaker must be 4Ω or higher.

**Main:** If you use one pair of main speakers, the impedance of each speaker must be 8Ω or higher.

#### <Except Canada model>

If you use two pairs of main speakers, the impedance of each speaker must be 16Ω or higher.

## ANTENNA CONNECTIONS

- Each antenna should be connected to the designated terminals correctly, referring to the following diagram.
- Both AM and FM indoor antennas are included with this unit. In general, these antennas will probably provide sufficient signal strength. Nevertheless, a properly installed outdoor antenna will give clearer reception than an indoor one. If you experience poor reception quality, an outdoor antenna may result in improvement.

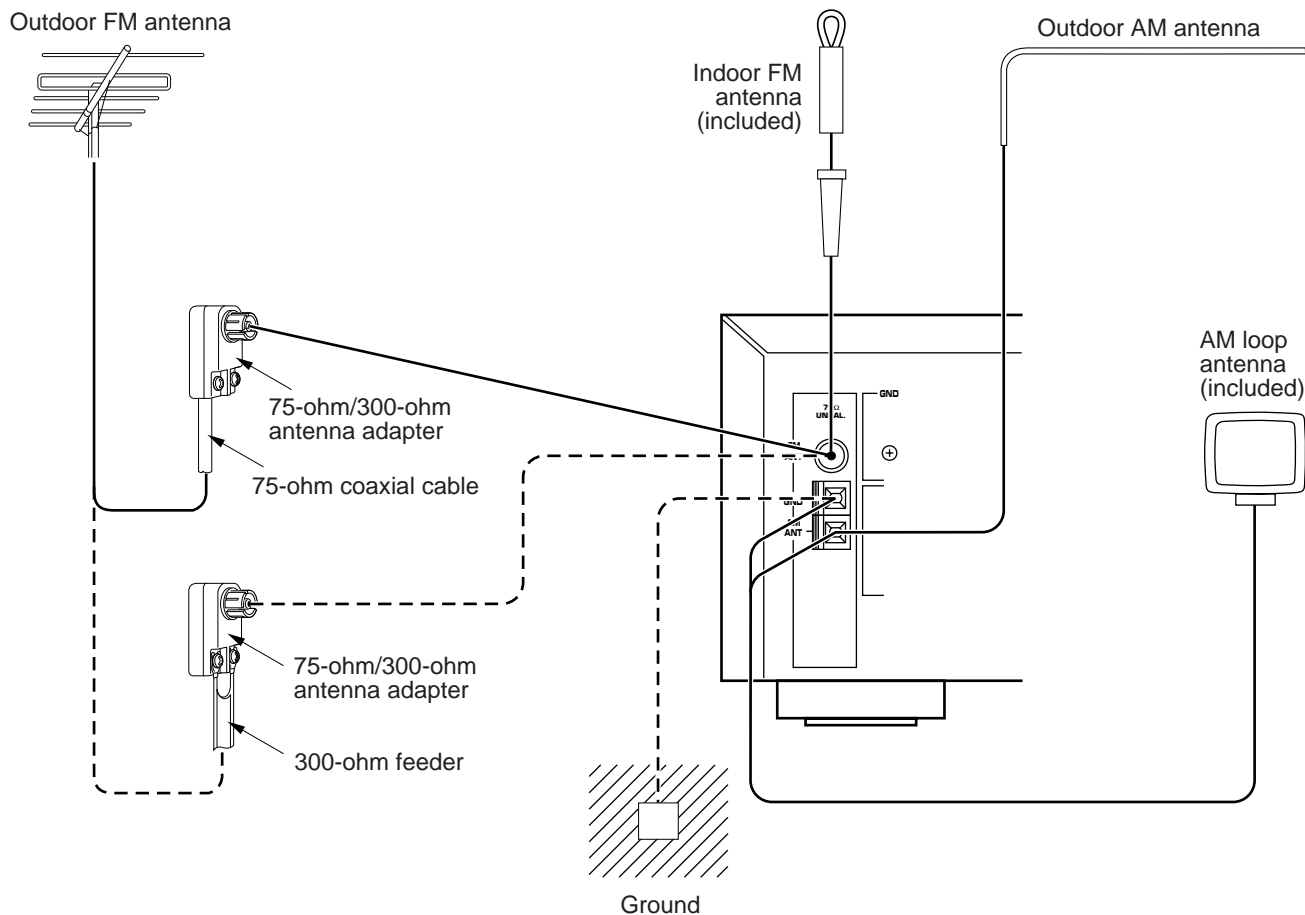

### Connecting the AM loop antenna

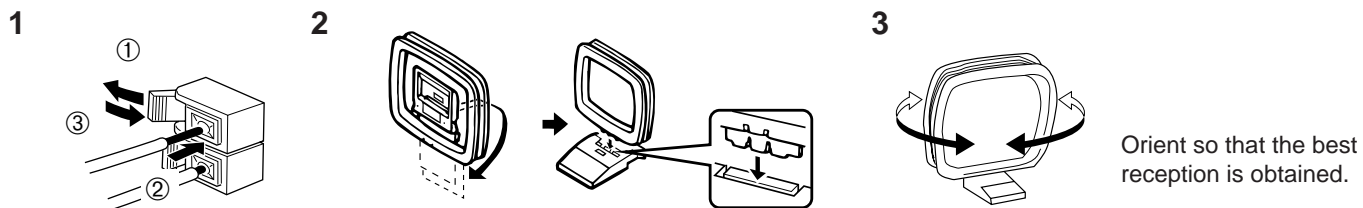

- \* The AM loop antenna should be placed apart from the main unit. The antenna may be hung on a wall.
- \* The AM loop antenna should be kept connected, even if an outdoor AM antenna is connected to this unit.

### GND terminal

For maximum safety and minimum interference, connect the **GND** terminal to a good earth ground. A good earth ground is a metal stake driven into moist earth.

### Notes

- When connecting the indoor FM antenna, insert its connector into the **FM ANT** terminal firmly.
- If you need an outdoor FM antenna to improve FM reception quality, either 300-ohm feeder or coaxial cable may be used. In locations troubled by electrical interference, coaxial cable is preferable.

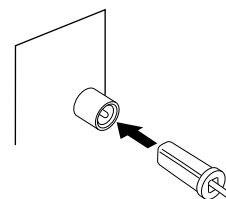

# CONTROLS AND THEIR FUNCTIONS

## FRONT PANEL

### R-V702

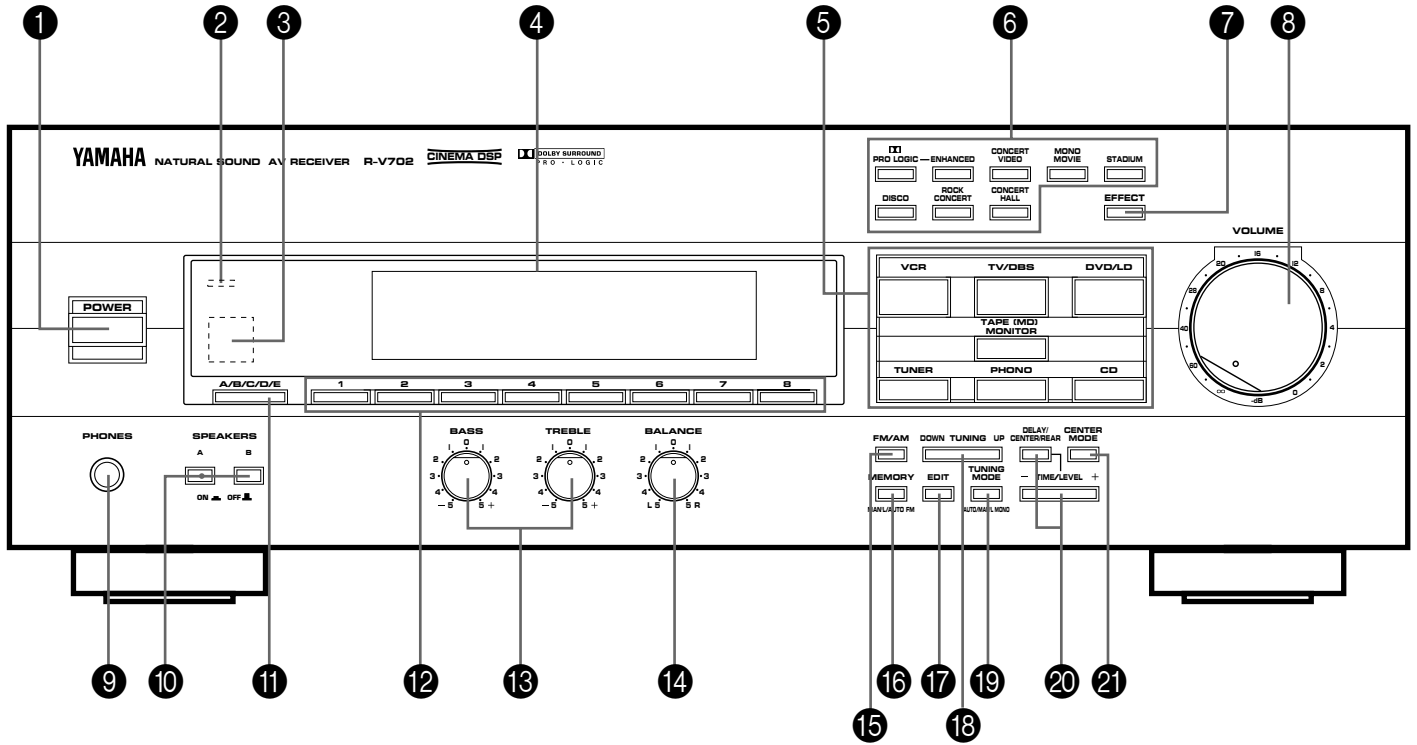

### R-V502

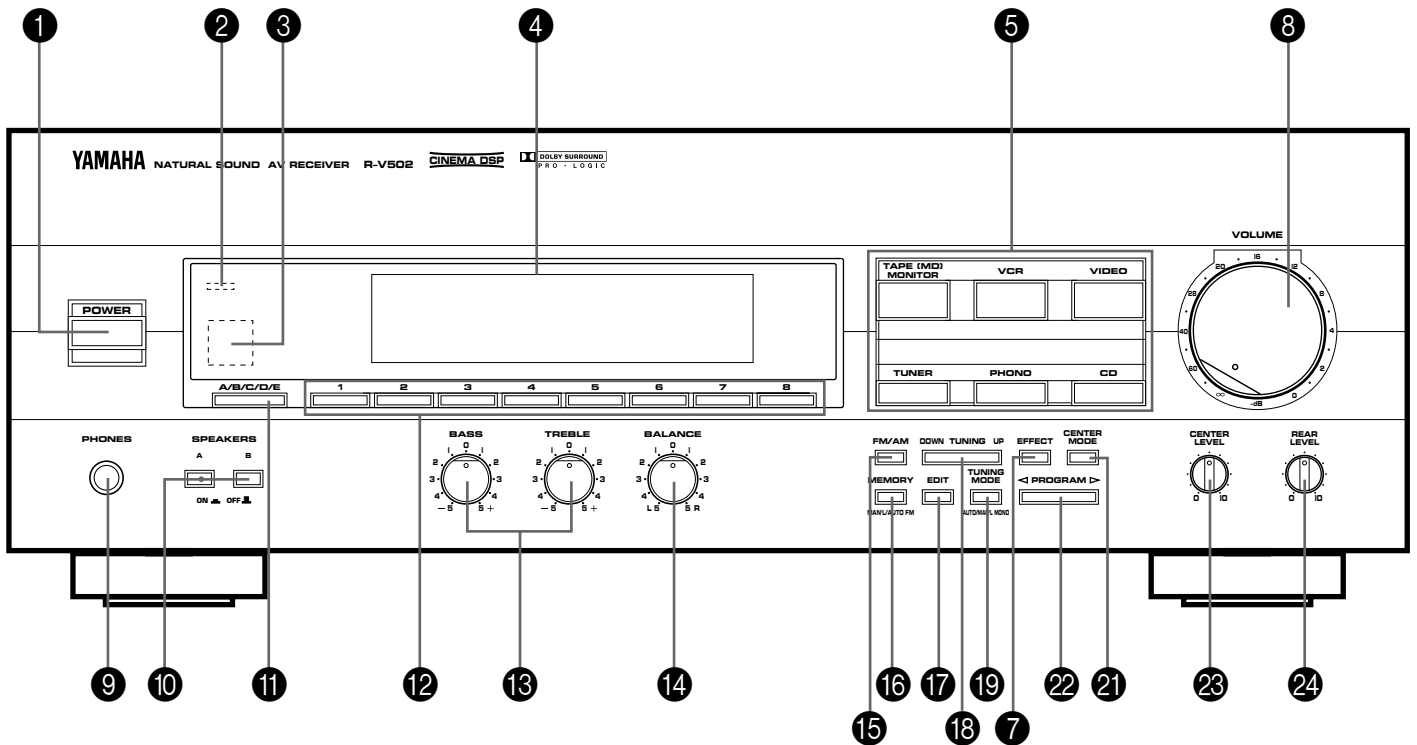



**1 POWER switch**

Press this switch to switch the power on. Press it again to switch the power off.

**2 Standby mode indicator  
(Except U.S.A. and Canada models)**

While the power is on, pressing the **SYSTEM POWER OFF** key on the remote control transmitter switches the unit to the standby mode. In this mode, this indicator is illuminated.

**3 Remote control sensor**

Receives signals from the remote control transmitter.

**4 Display panel**

Shows various information. (Refer to page 17 for details.)

**5 Input selector buttons**

Select a program source to listen to or watch. When a button is pressed, the name of selected source appears on the display.

**6 DSP program selector buttons****R-V702 only**

Select a DSP program. When a button is pressed, the name of selected program lights up on the display.

**7 EFFECT button**

Switches on/off the digital sound field processor (including the Dolby Pro Logic Surround decoder).

**8 VOLUME control**

Used to raise or lower the volume level.

**9 PHONES jack**

When you listen with headphones, connect the headphones to the **PHONES** jack. You can listen to the sound to be output from the main speakers through headphones.

When listening with headphones privately, set both the **SPEAKERS A** and **B** switches to the **OFF** position and switch off the digital sound field processor (so that no DSP program name is illuminated on the display) by pressing the **EFFECT** button.

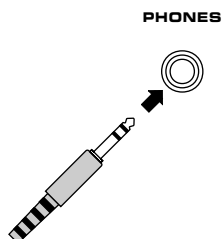
**10 SPEAKERS switches**

Set the switch **A** or **B** (or both **A** and **B**) for the main speaker system (connected to this unit) you will use to the **ON** position. Set the switch for the main speaker system you will not use to the **OFF** position.

**11 A/B/C/D/E button**

Press this button to select a desired group (A–E) of preset stations.

**12 Preset station number selector buttons**

Select a preset station number (1 to 8).

**13 Tone controls**

These controls are effective only for the sound from the main speakers.

**BASS**

Used to increase or decrease the low frequency response. The 0 position produces flat response.

**TREBLE**

Used to increase or decrease the high frequency response. The 0 position produces flat response.

**14 BALANCE control**

Adjusts the balance of the output volume to the left and right speakers to compensate for sound imbalance caused by speaker location or listening room conditions.

**15 FM/AM buttons**

Press this button to switch the reception band to FM or AM.

**16 MEMORY (MAN'L/AUTO FM) button**

When this button is pressed, the MEMORY indicator flashes for about 5 seconds. During this period, select a desired preset station number by pressing the corresponding preset station number selector button to enter the displayed station into the memory.

When this button is pressed and held for about 3 seconds, the automatic preset tuning begins. (Refer to page 28 for details.)

**17 EDIT button**

This button is used to exchange the places of two preset stations with each other.

**18 TUNING DOWN/UP button**

Used for tuning. Press the "UP" side to tune in to higher frequencies, and press the "DOWN" side to tune in to lower frequencies.

**19 TUNING MODE (AUTO/MAN'L MONO) button**

Press this button to switch the tuning mode to automatic or manual. To select the automatic tuning mode, press this button so that "AUTO" lights up on the display. To select the manual tuning mode, press this button so that "AUTO" goes off.

**20 DELAY/CENTER/REAR and TIME/LEVEL +/- buttons**

**R-V702 only**

Adjust the delay time (DELAY), the rear channel output level (REAR) and the center channel output level (CENTER). Select the item which you want to adjust by pressing the **DELAY/CENTER/REAR** button and adjust its time or level by pressing the **TIME/LEVEL +/-** button.

**21 CENTER MODE button**

Selects a center channel output mode (NORMAL, WIDE or PHANTOM). (For details, refer to page 21.)

**22 PROGRAM selector button**

**R-V502 only**

When the built-in digital sound field processor (including the Dolby Pro Logic Surround decoder) is on, this button changes the currently selected DSP program whenever the right or left side of this button is pressed.

**23 CENTER LEVEL control**

**R-V502 only**

Adjusts the sound output level of the center speaker.

**24 REAR LEVEL control**

**R-V502 only**

Adjusts the sound output level of the rear speakers.

## DISPLAY PANEL

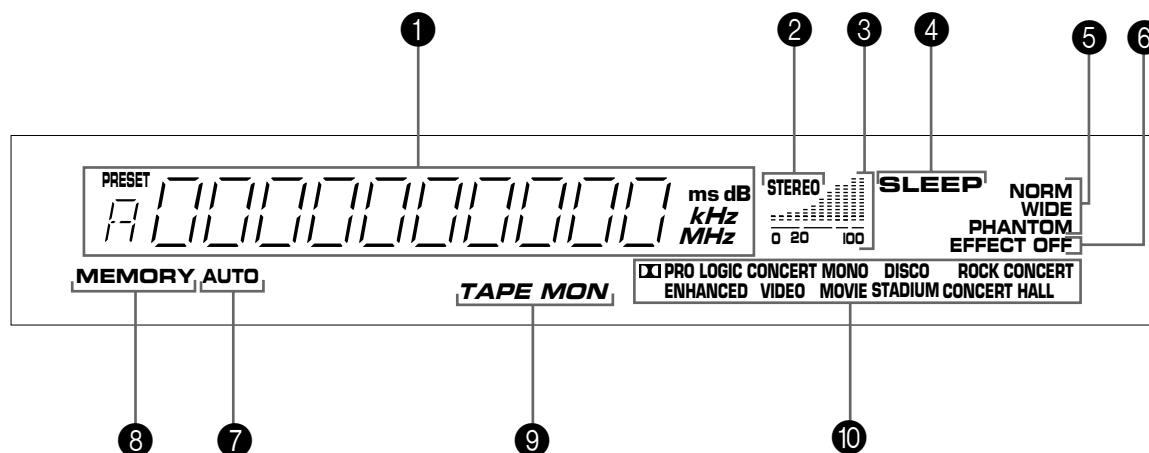

### 1 Multi-information display

Displays various information, for example station frequency, preset station number and name of selected input source.

### 2 STEREO indicator

Lights up when an FM stereo broadcast with sufficient signal strength is received.

### 3 Signal-level meter

Indicates the signal level of the received station. If multipath interference is detected, the indication decreases.

### 4 SLEEP indicator

Lights up while the built-in SLEEP timer is functioning.

### 5 Center channel mode indicators

The name of a selected center channel mode lights up only when a program which uses the Dolby Pro Logic Surround decoder is selected.

### 6 EFFECT OFF indicator

Lights up if neither the digital sound field processor nor the Dolby Pro Logic Surround decoder is on. In this state, sound output is 2-channel stereo.

### 7 AUTO indicator

Lights up when this unit is in the automatic tuning mode.

### 8 MEMORY indicator

When the **MEMORY** button is pressed, this indicator flashes for about 5 seconds. During this period, the displayed station can be programmed to the memory by using the **A/B/C/D/E** button and the preset station number selector buttons.

### 9 TAPE MON indicator

Lights up when the tape deck (or MD recorder etc.) is selected as the input source by pressing the **TAPE (MD) MONITOR** button.

### 10 DSP program indicators

The name of a selected DSP program lights up when the built-in digital sound field processor and/or the Dolby Pro Logic Surround decoder is on.

# REMOTE CONTROL TRANSMITTER

The remote control transmitter provided with this unit is designed to control all the most commonly used functions of this unit. If the CD player and tape deck connected to this unit are YAMAHA components designed for remote control compatibility, then this remote control transmitter will also control various functions of each component.

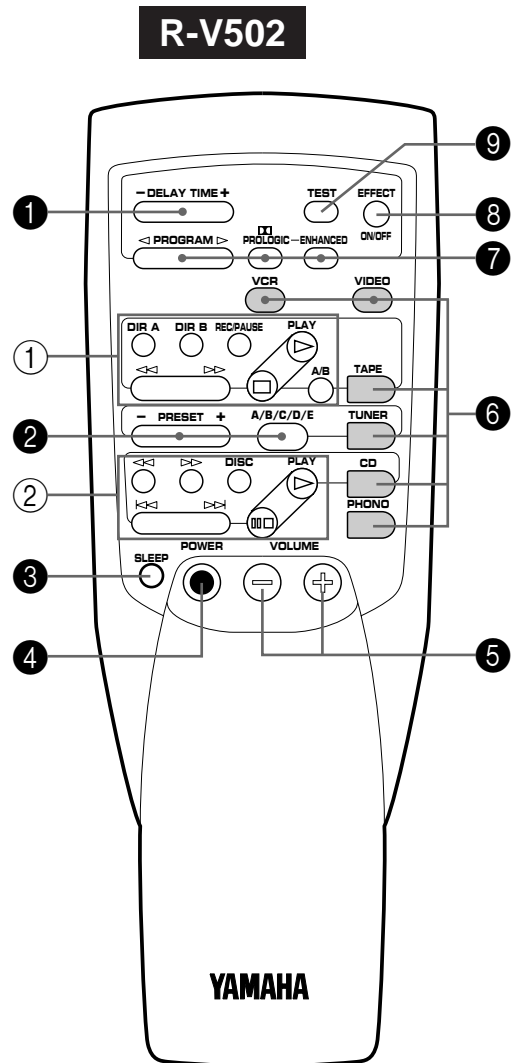
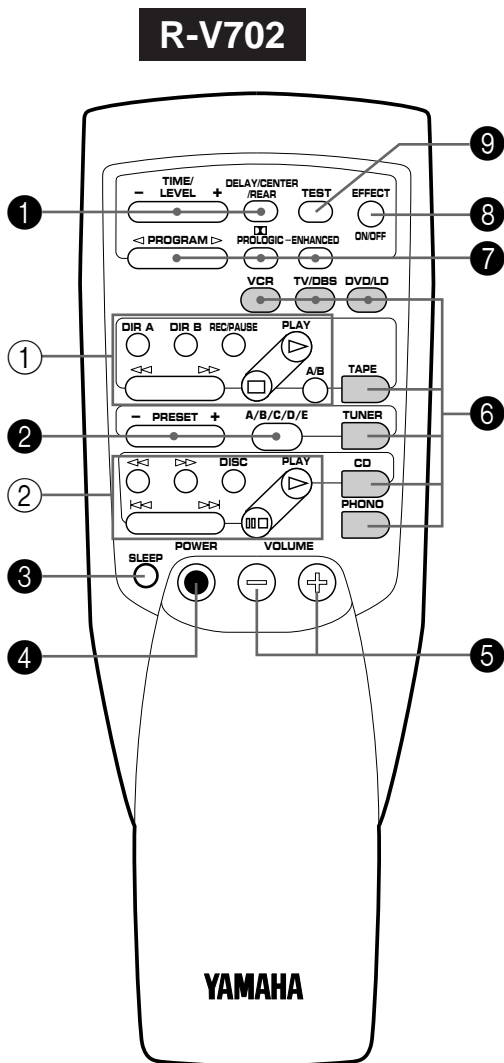

## For Control of This Unit

### ① DELAY/CENTER/REAR and TIME/LEVEL +/- keys

#### R-V702 only

Adjust the delay time (DELAY), the rear channel output level (REAR) and the center channel output level (CENTER).

Select the item which you want to adjust by pressing the **DELAY/CENTER/REAR** key and adjust its time or level by pressing the **TIME/LEVEL +/-** key.

#### DELAY TIME +/- key

#### R-V502 only

Adjusts the delay time, or the time difference between the beginning of source sound and the beginning of effect sound.

(For details, refer to page 33.)

### ② Tuner keys

Controls tuner.

**+**: Selects higher preset station number.

**-**: Selects lower preset station number.

**A/B/C/D/E**: Selects the group (A – E) of preset station numbers.

### ③ SLEEP timer key

This key is used to turn the built-in SLEEP timer on and off, and to set the SLEEP time. (See page 34 for details.)

### ④ POWER key

Turns the power on/off.

\* (Except U.S.A. and Canada models)

While the power is on, pressing the **POWER** key on the remote control transmitter switches the unit from the power-on mode to the standby mode, and vice versa. (In the standby mode, the standby mode indicator on the front panel is illuminated.)

### ⑤ VOLUME +/- keys

Turns the volume level up/down.

### ⑥ Input selector keys

Selects input source.

### ⑦ Program selector keys

#### PROGRAM:

When the built-in digital sound field processor (including the Dolby Pro Logic Surround decoder) is on, this key changes the currently selected DSP program whenever the right or left side of this key is pressed.

#### PROLOGIC:

Directly selects the **PRO LOGIC** program.

#### ENHANCED:

Directly selects the **PRO LOGIC ENHANCED** program.

### ⑧ EFFECT ON/OFF key

Switches on/off the digital sound field processor (including the Dolby Pro Logic Surround decoder).

### ⑨ TEST key

Used for speaker balance adjustment. (For details, refer to page 20–22.)

## For Other Component Control

Identify the remote control transmitter keys with your component's keys. If these keys are identical, their functions will be the same. On each key function, refer to the corresponding instruction on your component's manual.

### ① Tape deck keys

Controls tape deck.

\* **DIR A, B** and **A/B** are applicable only to double cassette tape deck.

\* For a single cassette deck with automatic reverse function, pressing **DIR A** will reverse the direction of tape running.

### ② CD player keys

Controls compact disc player.

\* **DISC** is applicable only to compact disc changer.

# SPEAKER BALANCE ADJUSTMENT

This procedure lets you adjust the sound output level balance between the main, center, and rear speakers using the built-in test tone generator. When this adjustment is performed, the sound output level heard at the listening position will be the same from each speaker. This is important for the best performance of the digital sound field processor and the Dolby Pro Logic Surround decoder.

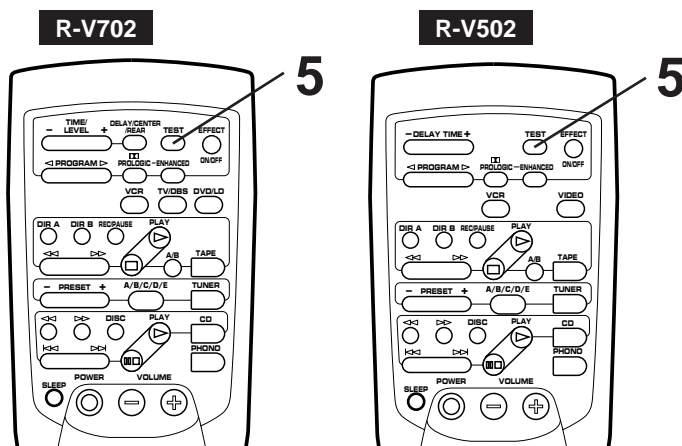
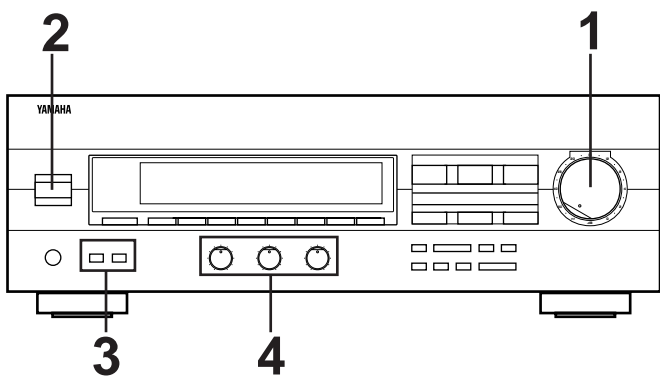

**1**

Set to the "∞" position.

---

**2** Turn the power on.

**3** Select the main speakers to be used.

**SPEAKERS**

A B

\* If you use two main speaker systems, press both the A and B switches.

---

**4**

Set to the "0" position.

---

**5**

TEST LEFT

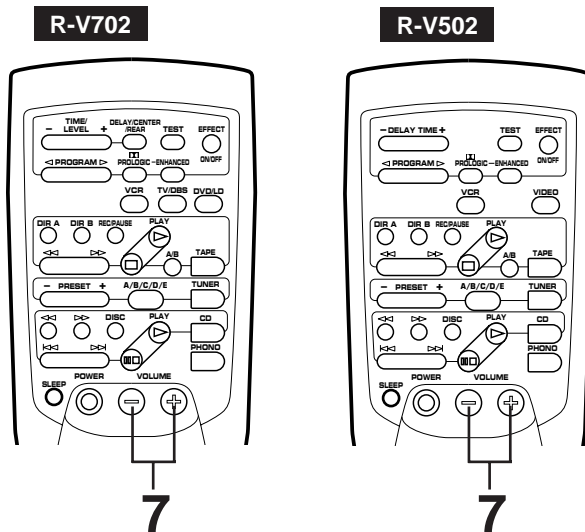
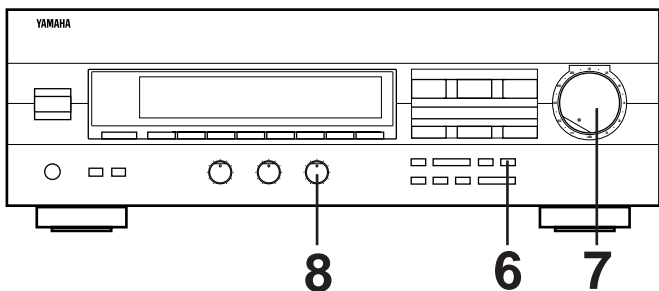

**6** Select the center channel output mode suitable for your speaker configuration.  
(Refer to "SPEAKER CONFIGURATION" on page 7.)

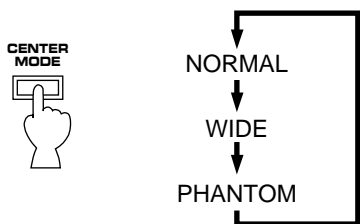

On the feature of each mode, refer to the "Note" shown below.

**Note**

In step 6, when you select a center channel output mode, note the following.

**For 5 speaker configuration)**

**NORMAL:** Select this mode when you use a center speaker that is smaller than the main speakers. In this mode, the bass tone will be output from the main speakers.

**WIDE:** Select this mode when you use the center speaker approximately same sized as the main speakers.

**For 4 speaker configuration)**

**PHANTOM:** Select this mode when you do not use the center speaker. The center sound will be output from the left and right main speakers.

**7** Turn up the volume.

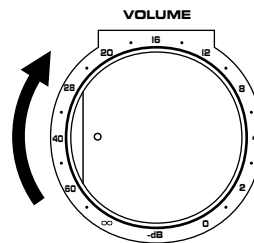

You will hear a test tone (like pink noise) from the left main speaker, then the center speaker, then the right main speaker, and then the rear speakers, for about two seconds each. The display changes as shown below.

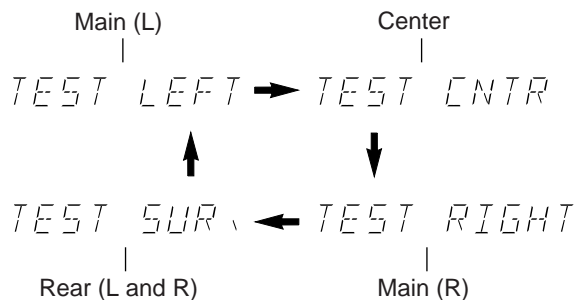

\* The test tone from the left rear speaker and the right rear speaker will be heard at the same time.

**8** Adjust the **BALANCE** control so that the effect sound output level of the left main speaker and the right main speaker are the same.



**CONTINUED**

**R-V702**

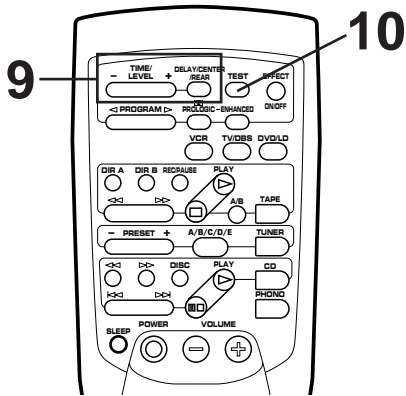

**R-V502**

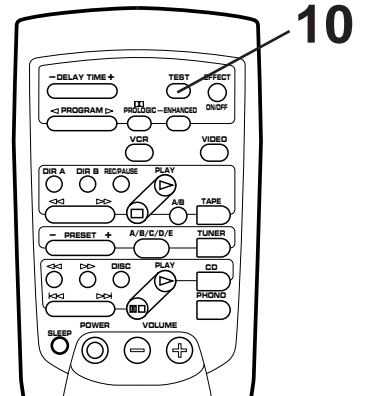
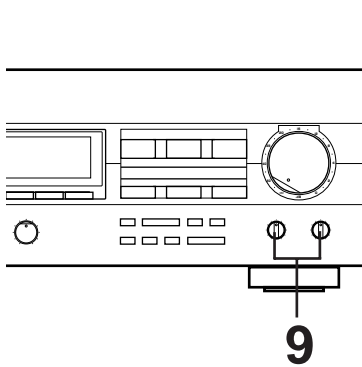

**9** Adjust the sound output levels of the center speaker and the rear speakers so that they become almost as same as that of the main speakers.

**R-V702**

Make the adjustment of each speaker output level at your listening position with the remote control transmitter.

- a) Press once or more so that "CENTER" or "REAR" appears on the display.
  - \* Select "CENTER" to adjust the output level of the center speaker, and select "REAR" to adjust the output level of the rear speakers.



- b) Adjust its level.
  - \* Pressing the + side raises and the - side lowers the level.

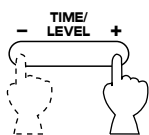

**R-V502**

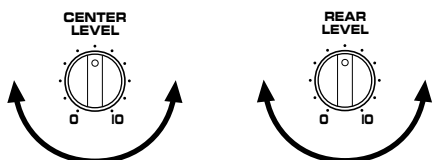

**10** Cancel the test tone.



TEST LEFT  
|  
Disappears.

**Notes**

- Once you have completed these adjustments, you can adjust whole sound level on your audio system by using the **VOLUME** control (or the **VOLUME** keys on the remote control transmitter) only.
- If you use external power amplifiers, you may also use their volume controls to achieve proper balance.

**R-V702 only**

In step 9, if the center channel mode is in the "PHANTOM" position, the sound output level of the center speaker cannot be adjusted. This is because in this mode, the center sound is automatically output from the left and right main speakers.



# BASIC OPERATIONS

## TO PLAY A SOURCE

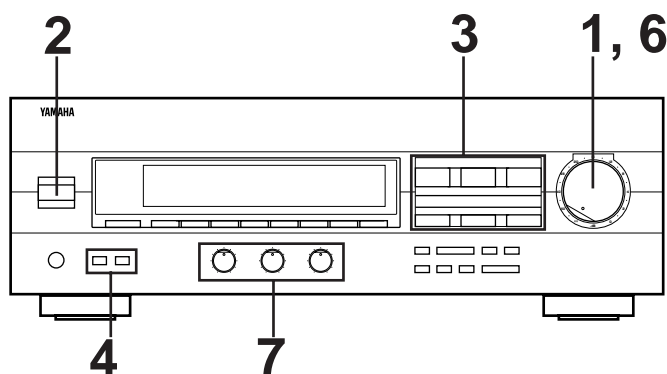

**1**

Set to the “∞” position.

**2** Turn the power on.

**3** Select the desired input source by using the input selector buttons.  
(For video sources, turn the TV/monitor ON.)

\* The name of the selected input source will appear on the display.

**4** Select the main speakers to be used.

\* If you use two main speaker systems, press both the A and B switches.

**5** Play the source. (For detailed information on the tuning operation, refer to page 26.)

**6**

Adjust to the desired output level.

**7** If desired, adjust the **BASS**, **TREBLE** and **BALANCE** controls (refer to page 25), and use the digital sound field processor. (Refer to page 31.)

### Notes on using the input selector buttons

- Note that pressing on each input selector button selects the source which is connected to the corresponding input terminals on the rear panel.
- The selection of **TAPE (MD) MONITOR** cannot be canceled by pressing another input selector button. To cancel it, press **TAPE (MD) MONITOR** again so that “TAPE MON” disappears from the display. When you select a button other than **TAPE (MD) MONITOR**, make sure that “TAPE MON” is not illuminated on the display.
- If you select the input selector button for a video source without canceling the selection of **TAPE (MD) MONITOR**, the playback result will be the video image from the video source and the sound from the audio tape (or MD etc.).
- Once you play a video source, its video image will not be interrupted even if the input selector button for an audio source is selected.

### To turn off the power

Press the **POWER** switch again.

## TO RECORD A SOURCE TO TAPE (OR MD)

**R-V702**

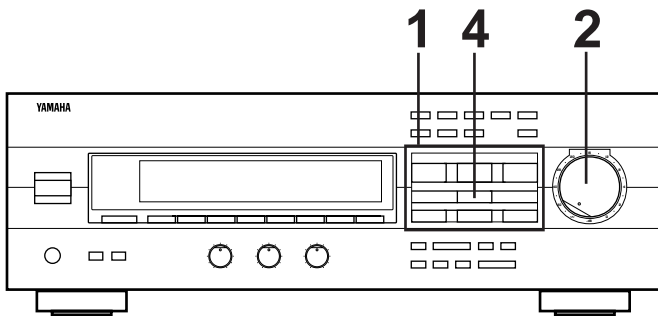

**R-V502**

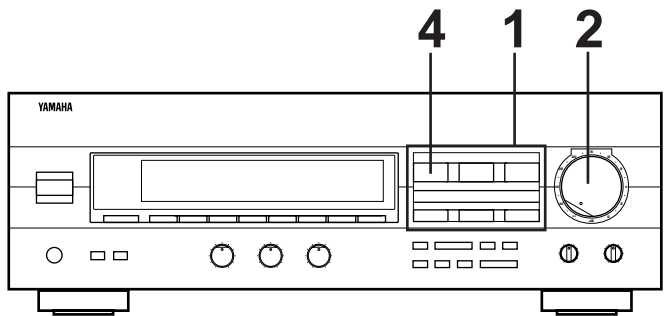

- 1** Select the source to be recorded.

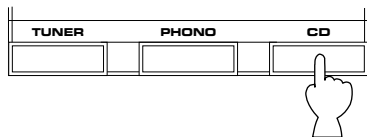

- 2** Play the source and then turn the **VOLUME** control up to confirm the input source. (For detailed information on the tuning operations, refer to the page 26.)

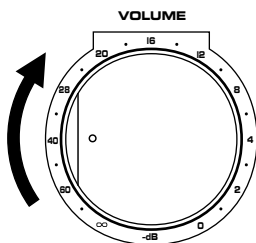

- 3** Begin recording on the tape deck (or MD recorder etc.) or VCR connected to this unit.

- 4** If the tape deck (or MD recorder etc.) is used for recording, you can monitor the sounds being recorded by pressing **TAPE (MD) MONITOR** so that "TAPE MON" lights up on the display.

**R-V702**

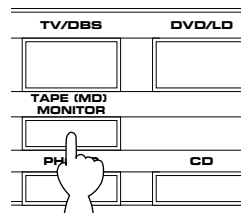

**R-V502**

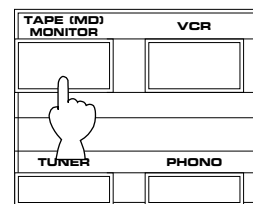

**Note**

The settings of DSP and the **VOLUME, BASS, TREBLE** and **BALANCE** controls have no effect on the material being recorded.

## Selecting the SPEAKER system

Because one or two speaker systems (as main speakers) can be connected to this unit, the **SPEAKERS** switches allow you to select speaker system **A** or **B**, or both at once.

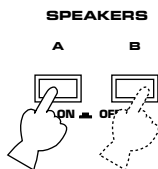

## Adjusting the BALANCE control

Adjust the balance of the output volume to the left and right speakers to compensate for sound imbalance caused by speaker location or listening room conditions.



### Note

This control is effective only for the sound from the main speakers.

## Adjusting the BASS and TREBLE controls

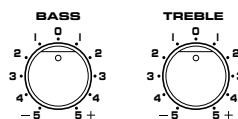

**BASS** : Turn this clockwise to increase (or counter-clockwise to decrease) the low frequency response.

**TREBLE** : Turn this clockwise to increase (or counter-clockwise to decrease) the high frequency response.

### Note

These controls are effective only for the sound from the main speakers.

# TUNING OPERATIONS

Normally, if station signals are strong and there is no interference, quick automatic-search tuning (AUTOMATIC TUNING) is possible. However, if signals of the station you want to select are weak, you must tune to it manually (MANUAL TUNING).

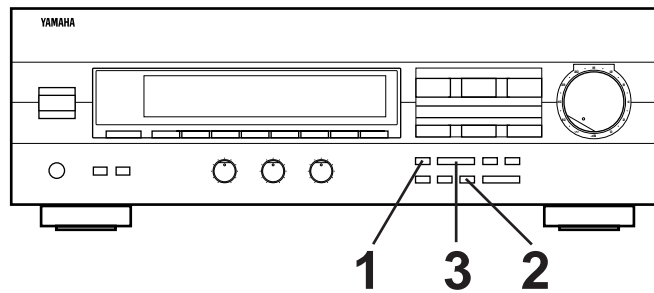

## AUTOMATIC TUNING

- 1 Select the reception band (FM or AM) confirming it on the display.

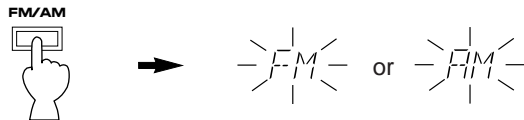

- 2

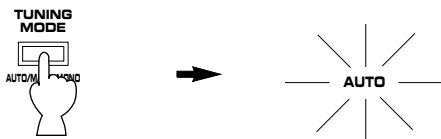

- 3

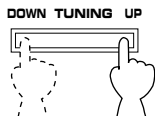

To tune to a higher frequency, press the right side once.  
 To tune to a lower frequency, press the left side once.

- \* If the station where tuning search stops is not the desired one, press again.
- \* If the tuning search does not stop at the desired station (because the signals of the station are weak), change to the MANUAL TUNING method.

## MANUAL TUNING

- 1 Select the reception band (FM or AM) confirming it on the display.

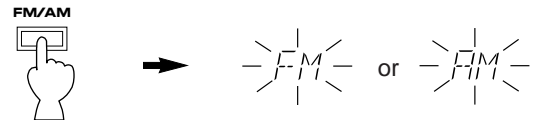

- 2

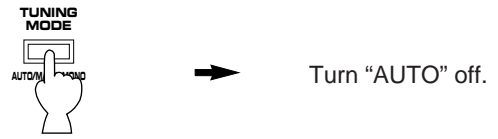

- 3 Tune to a desired station manually.

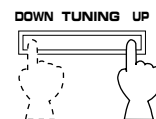

\* To continue tuning search, press and hold the button.

### Note

If you tune to an FM station manually, it is received in monaural mode automatically to increase the signal quality.

# PRESET TUNING

## MANUAL PRESET TUNING

This unit can store station frequencies selected by tuning operation. With this function, you can recall any desired station by only selecting the preset station number where it is stored. Up to 40 stations (8 stations x 5 groups) can be stored.

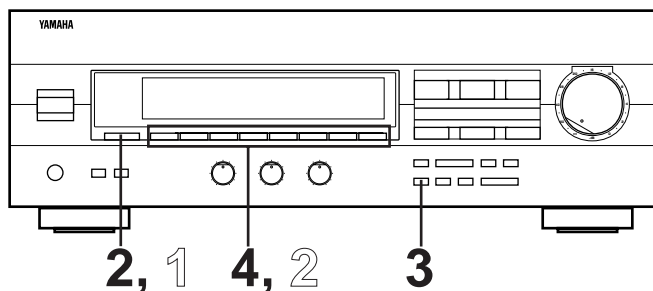

### To store stations

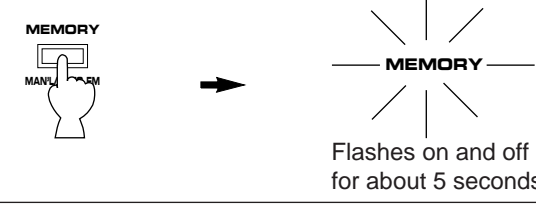
- 1 Tune to a desired station.  
(Refer to the previous page for tuning procedure.)
- 2 Select a desired group (A – E) of preset stations confirming it on the display.
 
- 3
 

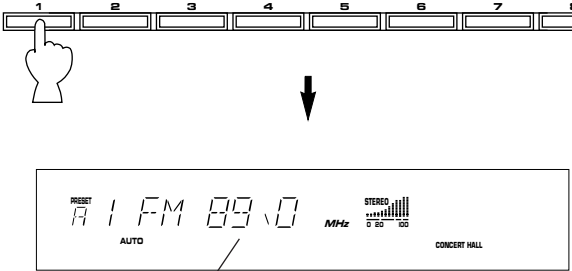
Flashes on and off for about 5 seconds.
- 4 Select a preset station number where you want to program the station before “MEMORY” goes off from the display.
 

Shows the displayed station has been programmed to A1.

\* In the same way, program other stations to A2, A3 ... A8.  
\* You can program more stations to preset station numbers on other groups in the same way by selecting other groups in step 2.

### To recall a preset station

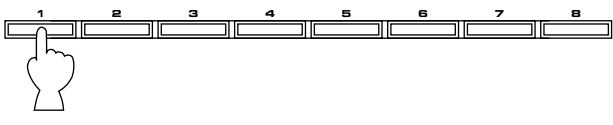
- 1 Select the group of preset stations.
 
- 2 Select the preset station number.
 

#### Notes

- A new setting can be programmed in place of the former one.
- For presets, the setting of the reception mode (stereo or monaural) is stored along with the station frequency.

#### Memory back-up

The memory back-up circuit prevents the programmed data from being lost even if the **POWER** switch is set off or the power plug is disconnected from the AC outlet or the power is cut due to temporary power failure. If, however, the power is cut for more than one week, the memory may be erased. If so, it can be re-programmed by simply following the PRESET TUNING steps.

## AUTOMATIC PRESET TUNING

You can also make use of an automatic preset tuning function for FM stations only. By this function, this unit performs automatic tuning and stores FM stations with strong signals sequentially. Up to 40 stations are stored automatically in the same way as in the manual preset tuning method on page 27.

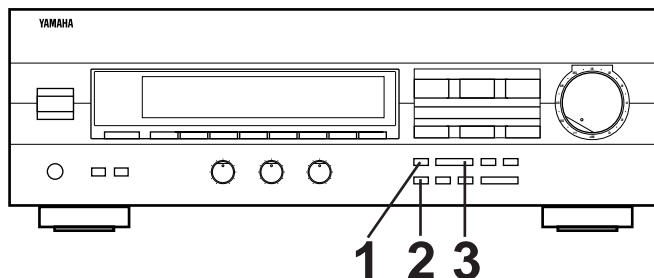

### To store stations

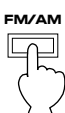
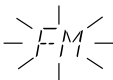
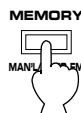
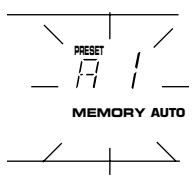
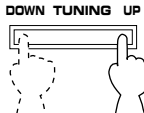
<b>1</b>	 
<b>2</b>	  <p>Press and hold for about 3 seconds.</p> <p style="text-align: center;">Flashes.</p>
<b>3</b>	 <p>To tune to higher frequencies, press right side once. To tune to lower frequencies, press left side once. * If the <b>TUNING</b> button is not pressed, in a while, the automatic preset tuning begins automatically toward higher frequencies.</p> <p>The automatic preset tuning begins from the frequency currently displayed. Received stations are programmed to A1, A2 ... A8 sequentially. * If more than 8 stations are received, they are also programmed to the preset station numbers on other groups (B, C, D and E) in that order.</p>

### When the automatic preset tuning is finished

The display shows the frequency of the last preset station. Check the contents and the number of preset stations by following the procedure of the section "To recall a preset station" on page 27.

### To recall a preset station

Simply follow the procedure of the section "To recall a preset station" on page 27.

### Notes

- You can replace a preset station by another FM or AM station manually by simply following the procedure of the section "To store stations" on page 27.
- If the number of received stations is not enough to be stored up to E8, the search is finished automatically after searching all frequencies.
- With this function, only FM stations with sufficient signal strength are stored automatically. If the station you want to program is weak in signal strength, tune to it in monaural manually and program it by following the procedure of the section "To store stations" on page 27.

### If you want to store the first station received by the automatic preset tuning to a desired preset station number.

If, for example, you want to store the first received station to C5, select "C5" by using the **A/B/C/D/E** button and the preset station number selector buttons after pressing the **MEMORY** button in step 2. Then press the **TUNING** button. The first received station is stored to C5, and next stations to C6, C7 ... sequentially.

If stations are stored up to E8, the automatic preset tuning is finished automatically.

## EXCHANGING PRESET STATIONS

You can exchange the places of two preset stations with each other as shown below.

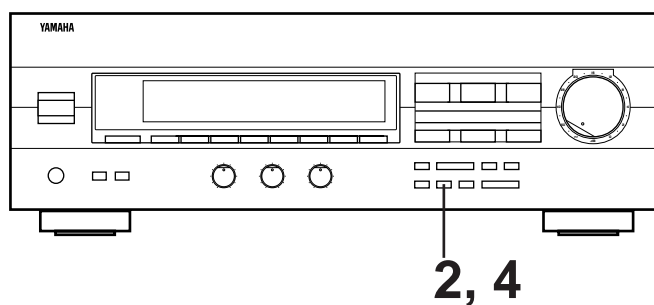

### Example)

If you want to shift the preset station on E1 to A5, and vice versa.

<b>1</b>	Recall the preset station on E1 (by following the method of "To recall a preset station" on page 27).
<b>2</b>	
<b>3</b>	Next, recall the preset station on A5 by following the same method with step 1. 

<b>4</b>	
----------	--

# USING DIGITAL SOUND FIELD PROCESSOR (DSP)

This unit incorporates a sophisticated, multi-program digital sound field processor. The processor allows you to electronically expand and change the shape of the audio sound field from both audio and video sources, creating a theater-like experience in your listening room. You can create an excellent audio sound field by selecting a suitable sound field program (this will, of course, depend on what you will be listening to), and adding desired adjustments.

In addition, this unit incorporates a Dolby Pro Logic Surround decoder for multi-channel sound reproduction of sources encoded with Dolby Surround. The operation of the Dolby Pro Logic Surround decoder can be controlled by selecting a corresponding DSP program including a combined operation of the Yamaha DSP and the Dolby Pro Logic Surround.

## Brief Overview of Digital Sound Field Programs

The following list gives you a brief description of the sound fields produced by each of the DSP programs. Keep in mind that most of these are precise digital recreations of actual acoustic environments. The data for these sound fields was recorded at actual locations using sophisticated sound field measurement equipment.

**Note**  
The channel level balance between the left and right rear effect speakers may vary depending on the sound field you are listening to. This is due to the fact that most of these sound field recreations are actual acoustic environments.

PROGRAM	FEATURE
<input checked="" type="checkbox"/> PRO LOGIC	This program is used for playback of sources encoded with Dolby Surround. The application of a sophisticated digital signal processing system reduces crosstalk and directs or steers the sound source more smoothly and precisely, as compared to conventional types.
<input checked="" type="checkbox"/> PRO LOGIC ENHANCED	This program is also used for playback of sources encoded with Dolby Surround. Enhancing the "Normal" Dolby Pro Logic, the DSP technology simulates the multi-surround speaker systems of a 35 mm movie theater. This effect creates a wide surround sound field, and expands the sound stage with an improved presence image. This program is used for musical based movies, as well as drama and comedy based movies.
CONCERT VIDEO	This program is effective for music videos and gives excellent depth and clarity for vocals. For opera, the orchestra and stage are ideally recreated, letting you feel as if you were in an actual concert hall.
MONO MOVIE	This program is designed specifically to enhance mono source programs. Compared to a strictly mono setting, the sound image created in this mode is wider and slightly forward of the speaker pair, lending an immediacy to the overall sound. It is particularly effective when used with old mono movies, news broadcasts and dialog.
STADIUM	This program gives you long delays between direct sounds and effect sounds, and extraordinarily spacious feel of a large stadium.
DISCO	This program recreates the acoustic environment of a lively disco in the heart of a very lively city. The sound is dense and highly concentrated. It is also characterized by a high-energy, "immediate" sound.
ROCK CONCERT	This program is ideally suited for rock music. You will experience a very dynamic or lively sound field.
CONCERT HALL	In this program, the center will appear to be deep behind the main speakers, creating an expansive large hall ambience. Orchestra and opera music are suited for this sound field.



## To play a source with the digital sound field processor

R-V702

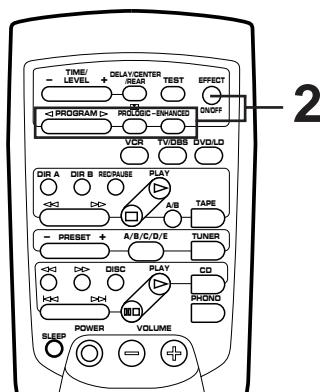
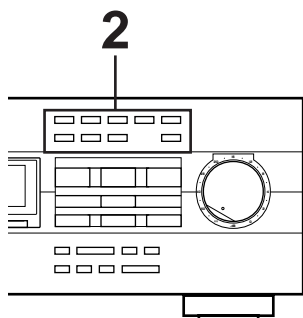

R-V502

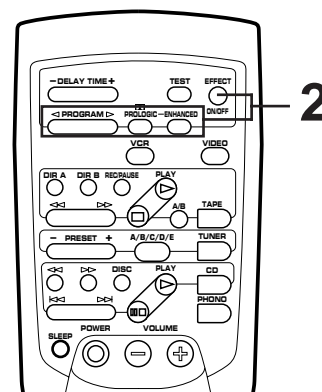
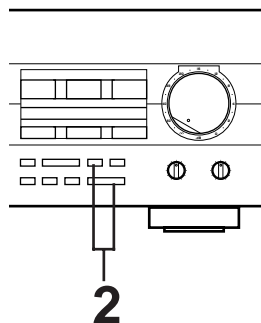

**1** Follow steps 1 – 6 shown in “**BASIC OPERATIONS**” on page 23.

**2** Select the desired program that is suitable for the source.

R-V702

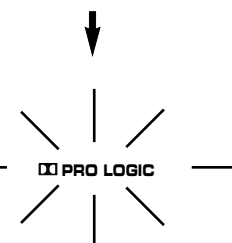
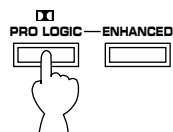

R-V502

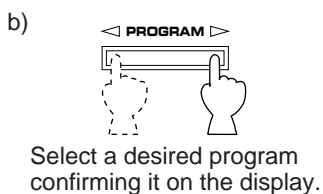
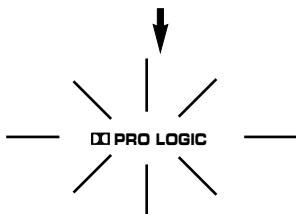
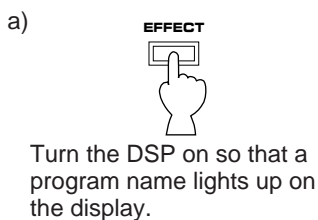

The selected program name is shown on the display.

**3** If desired, adjust the delay time and the output level of each speaker. (For details, refer to the corresponding descriptions on page 32 and 33.)

### Notes

- Program selection can be made to individual input sources. Once you select a program, it is linked with the input source selected at that time. So, when you select the input source next time, the same program is automatically called.
- If you prefer to cancel the DSP, press the **EFFECT** button. The sound will be the normal 2-channel stereo without surround sound effect.
- When **CONCERT VIDEO, MONO MOVIE, DISCO, STADIUM, ROCK CONCERT** or **CONCERT HALL** is selected, no sound is heard from the center speaker.
- When a monaural sound source is played with **DOLBY PRO LOGIC** or **DOLBY PRO LOGIC ENHANCED**, no sound is heard from the main speakers and the rear speakers. Sound is heard only from the center speaker. However, if the center channel mode is in **PHANTOM**, the main speakers output the sound of the center channel.
- When this unit's Dolby Pro Logic Surround decoder is used, if the main-source sound is considerably altered by overadjustment of the **BASS** or **TREBLE** control, the relationship between the center and rear channels may produce an unnatural effect.
- To select a DSP program on the remote control transmitter, first turn the DSP on so that a program name lights up on the display by pressing the **EFFECT** key. Next, select a desired DSP program by pressing the **<** or **>** side of **PROGRAM** key.

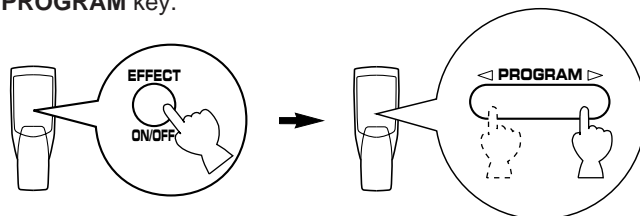

\* Pressing the **PRO LOGIC** or **ENHANCED** key turns the DSP on and selects the corresponding program directly.

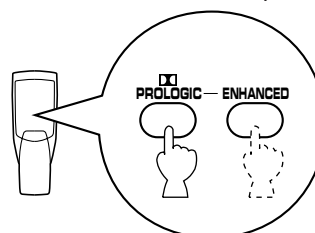

## Adjustment of the CENTER LEVEL

If desired, you can adjust the sound output level of the center speaker even if the output level is already set in "SPEAKER BALANCE ADJUSTMENT" on page 22.

### R-V702

- 1 Press once or more so that "CENTER" appears on the display.

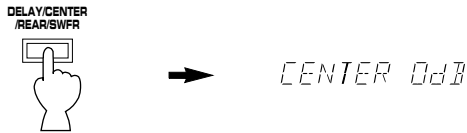

- 2 By continuously pressing the "+" or "-" side of the TIME/LEVEL button, the level value changes continuously. The value stops changing momentarily at the preset point (0 dB).

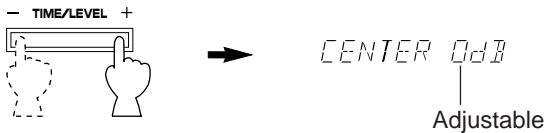

Control range: MIN, -20 to +10 dB

### Notes

- This adjustment can be made only when the digital sound field program **DOLBY PRO LOGIC** or **DOLBY PRO LOGIC ENHANCED** is selected.
- Once the output level is adjusted, the level value will be the same in all the digital sound field programs mentioned above.

### R-V502

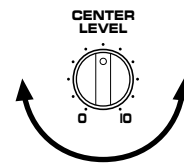

### Note

This adjustment is useful only when the digital sound field program **DOLBY PRO LOGIC** or **DOLBY PRO LOGIC ENHANCED** is selected.

## Adjustment of the REAR LEVEL

If desired, you can adjust the sound output level of the rear speakers even if the output level is already set in "SPEAKER BALANCE ADJUSTMENT" on page 22.

### R-V702

- 1 Press once or more so that "REAR" appears on the display.



- 2 By continuously pressing the "+" or "-" side of the TIME/LEVEL button, the level value changes continuously. The value stops changing momentarily at the preset point (0 dB).

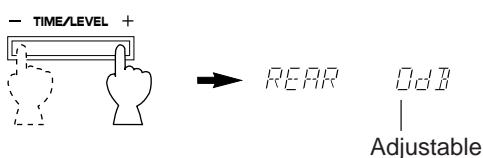

Control range: MIN, -20 to +10 dB

### Notes

- This adjustment can be made only when the built-in digital sound field processor is on.
- Once the output level is adjusted, the level value will be the same in all the digital sound field programs.

### R-V502

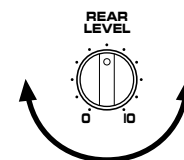

### Note

If no digital sound field program is used, this adjustment is useless.

## Adjustment of DELAY TIME

You can adjust the time difference between the beginning of the sound from the main speakers and the beginning of the effect sound from the rear speakers.  
The larger the value, the later the effect sound is generated.  
This adjustment can be made to all programs individually.

<b>PRO LOGIC</b>	: from 15 to 30 milliseconds (Preset value: 20 milliseconds)
<b>PRO LOGIC ENHANCED</b>	: from 15 to 30 milliseconds (Preset value: 20 milliseconds)
<b>CONCERT VIDEO</b>	: from 1 to 100 milliseconds (Preset value: 28 milliseconds)
<b>MONO MOVIE</b>	: from 1 to 100 milliseconds (Preset value: 20 milliseconds)
<b>STADIUM</b>	: from 1 to 50 milliseconds (Preset value: 45 milliseconds)
<b>DISCO</b>	: from 1 to 100 milliseconds (Preset value: 14 milliseconds)
<b>ROCK CONCERT</b>	: from 1 to 100 milliseconds (Preset value: 17 milliseconds)
<b>CONCERT HALL</b>	: from 1 to 100 milliseconds (Preset value: 30 milliseconds)

### R-V702

- 1 Press once or more so that "DELAY" appears on the display.

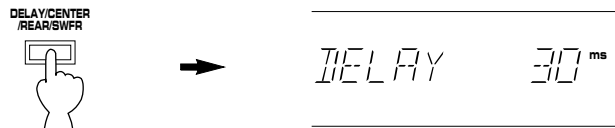

- 2 By continuously pressing the "+" or "-" side of the **TIME/LEVEL** button, the value changes continuously. The value stops changing momentarily at the preset point.

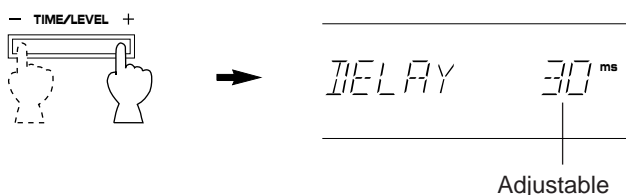

- \* When the **TIME/LEVEL** button is pressed, sound is momentarily interrupted.

### R-V502

This adjustment can be made by only using the remote control transmitter.

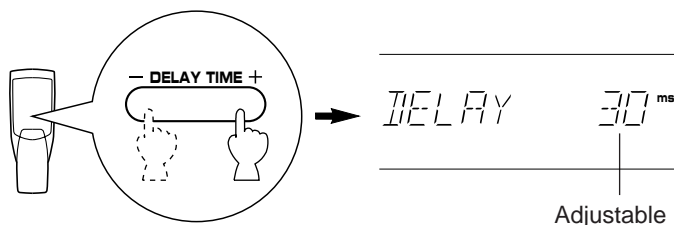

- \* When the **DELAY TIME** key is pressed, sound is momentarily interrupted.

#### Note

Adding too much delay will cause an unnatural effect with some sources.

#### Notes

##### R-V702 only

The values of the delay time, center level and rear level you set the last time will remain memorized even when the power of this unit is off.

However, if the power cord is kept disconnected for more than one week, these values will be automatically changed back to the original factory settings.

##### R-V502 only

The value of the delay time you set the last time will remain memorized even when the power of this unit is off. However, if the power cord is kept disconnected for more than one week, these values will be automatically changed back to the original factory settings.

# SETTING THE SLEEP TIMER

If you use the SLEEP timer of this unit, you can make this unit turn off automatically. When you are going to sleep while enjoying a broadcast or other desired input source, this timer function is helpful.

## Notes

- The SLEEP timer can be controlled only with the remote control transmitter.
- The components on which the SLEEP timer is effective are the sources connected to the **SWITCHED AC OUTLET(S)** on the rear panel of this unit.

## To set the SLEEP time

1

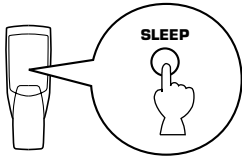

Press once or more to select the desired SLEEP time.



Indicates the SLEEP time.

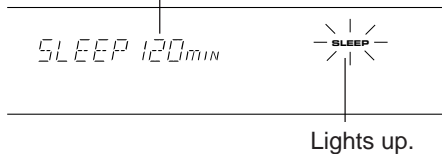

Whenever the **SLEEP** key is pressed, the SLEEP time will change as follows.

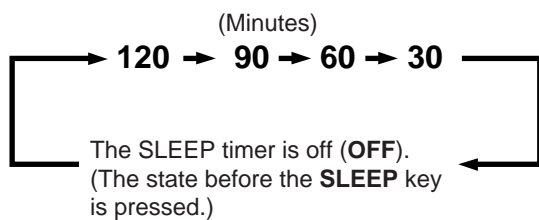

After a while, the display returns to the indication before the SLEEP timer is set.

2 The unit will be turned off automatically at the selected SLEEP time.

## To cancel the selected SLEEP time

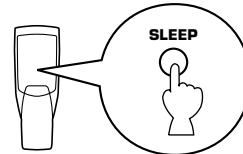

Press once or more so that "SLEEP OFF" appears on the display. (It will soon disappear and the "SLEEP" indicator will go off from the display.)

## Note

The SLEEP timer setting can also be canceled by turning off the power with the **POWER** switch or disconnecting the power plug of this unit from the AC outlet.

# TROUBLESHOOTING

If the unit fails to operate normally, check the following points to determine whether the fault can be corrected by the simple measures suggested. If it cannot be corrected, or if the fault is not listed in the SYMPTOM column, disconnect the power cord and contact your authorized YAMAHA dealer or service center for help.

	SYMPTOM	CAUSE	REMEDY
Amplifier	The unit fails to turn on when the POWER switch is pressed, or turns off suddenly soon after the power is turned on.	Power cord is not plugged in or is not completely inserted.	Firmly plug in the power cord.
		The IMPEDANCE SELECTOR switch on the rear panel is not set to the upper or the lower end exactly.	Set the switch to the upper or the lower end exactly.
	No sound or no picture.	Incorrect output cord connections.	Connect the cords properly. If the problem persists, the cords may be defective.
		Appropriate input source is not selected.	Select an appropriate input source with the input selector buttons.
		The SPEAKERS switches are not set properly.	Set the SPEAKERS switch which corresponds to the speakers to be used to the ON position.
		Speaker connections are not secure.	Secure the connections.
	The sound suddenly goes off.	The protection circuit has been activated because of short circuit etc.	Turning the unit off and then on will reset the protection circuit.
		The SLEEP timer has functioned.	Cancel the SLEEP timer function.
	Only one side speaker outputs the sound.	Incorrect setting of the BALANCE control.	Adjust it to the appropriate position.
		Incorrect cord connections.	Connect the cords properly. If the problem persists, the cords may be defective.
Sound "hums".	Incorrect cord connections.	Firmly connect the audio plugs. If the problem persists, the cords may be defective.	
	No connection from the turntable to the GND terminal.	Make the GND connection between the turntable and this unit.	
The volume level is low while playing a record.	The record is being played on a turntable with an MC cartridge.	The player should be connected to the unit through the MC head amplifier.	
The volume level cannot be increased, or sound is distorted.	The power to the component connected to the REC OUT terminals of this unit is off.	Turn the power to the component on.	
No sound from the rear speakers.	The sound output level to the rear speakers is set to 0.	Raise the sound output level to the rear speakers.	
	The monaural sound source is played in DOLBY PRO LOGIC or DOLBY PRO LOGIC ENHANCED mode.	Select another program suitable for the monaural sound source.	
No sound from the center speaker.	The sound output level to the center speaker is set to 0.	Raise the sound output level to the center speaker.	
	The center channel mode is in PHANTOM mode.	Select NORMAL or WIDE.	
	Incorrect sound field program selection.	Select the appropriate program.	
FM stereo reception is noisy.	Because of the characteristics of FM stereo broadcasts, this is limited to cases where the transmitter is too far away or the antenna input is poor.	Check the antenna connections. Try using a high quality directional FM antenna. Set the TUNING MODE button to the manual tuning mode.	
FM	There is distortion and clear reception cannot be obtained even with a good FM antenna.	There is multipath interference.	Adjust antenna placement to eliminate multipath interference.
	A desired station cannot be tuned in with the automatic tuning method.	The station is too weak.	Use the manual tuning method. Use a high quality directional FM antenna.
	Previously preset stations can no longer be tuned in.	This unit has been unplugged for a long period.	Repeat the presetting procedure.
AM	A desired station cannot be tuned in with the automatic tuning method.	Weak signal or loose antenna connections.	Tighten the AM loop antenna connections and rotate it for best reception. Use the manual tuning method.
	There are continuous crackling and hissing noises.	Noises will result from lightning, fluorescent lamps, motors, thermostats and other electrical equipment.	Use an outdoor antenna and a ground wire. This will help somewhat but it is difficult to eliminate all noise.
	There are buzzing and whining noises (especially in the evening).	A television set is being used nearby.	Relocate this unit away from the TV.
Remote control Transmitter	The remote control transmitter does not work.	Direct sunlight or lighting (of an inverter type of fluorescent lamp etc.) is striking the remote control sensor of the main unit.	Change the position of the main unit.
		The batteries of this remote control transmitter are too weak.	Replace the batteries with new ones.
Others	The sound is degraded when listening with the headphones connected to the compact disc player or cassette deck that are connected with this unit.	The power to this unit is off.	Turn the power to this unit on.

# SPECIFICATIONS

## AUDIO SECTION

Minimum RMS Output Power per Channel	
Main L, R	
8 ohms, 1 kHz, 0.09% THD	
<R-V702> .....	80W + 80W
<R-V502>	
[U.S.A. model] .....	70W + 70W
[Australia Canada and General models]	
.....	60W + 60W
Center	
8 ohms, 1 kHz, 0.09% THD	
<R-V702> .....	80W
<R-V502>	
[U.S.A. model] .....	70W
[Australia Canada and General models]	
.....	60W
Rear	
8 ohms, 1 kHz, 0.7% THD .....	20W + 20W
Maximum Power [General model only]	
(8 ohms, 1 kHz, 10% THD)	
Main L, R	
<R-V702> .....	100W + 100W
<R-V502> .....	75W + 75W
Center	
<R-V702> .....	100W + 100W
<R-V502> .....	75W + 75W
Rear .....	30W + 30W
Dynamic Power per Channel	
(by IHF Dynamic Headroom measuring method)	
<R-V702>	
[U.S.A. and Canada models]	
8/6/4/2 ohms .....	100/120/150/175W
[Australia and General models]	
8/6/4/2 ohms .....	95/115/145/165W
<R-V502>	
[U.S.A. model]	
8/6/4/2 ohms .....	90/110/140/170W
[Australia, Canada and General models]	
8/6/4/2 ohms .....	80/100/120/135W
Dynamic Headroom (8 ohms)	
[U.S.A. and Canada models only]	
<R-V702> .....	1.55 dB
<R-V502>	
[U.S.A. model only] .....	1.76 dB
[Canada model only] .....	2.04 dB
Power Band Width	
<R-V702>	
8 ohms, 30W, 0.1% THD	
.....	10 Hz to 50 kHz
<R-V502>	
8 ohms, 25W, 0.1% THD	
.....	10 Hz to 50 kHz
Damping Factor (SPEAKERS A)	
8 ohms, 20 Hz to 20 kHz .....	80 or more

Input Sensitivity/Impedance	
PHONO MM .....	2.5 mV/47 k-ohms
CD/TAPE/DVD-LD/TV-DBS/VCR	
.....	150 mV/47 k-ohms
Maximum Input Signal	
PHONO MM	
1 kHz, 0.5% THD .....	100 mV
CD/TAPE/DVD-LD/TV-DBS/VCR	
(EFFECT OFF)	
1 kHz, 0.5% THD .....	2.5V
Output Level/Impedance	
REC OUT .....	150 mV/2.5 k-ohms
SUBWOOFER (EFFECT OFF)	
.....	3.5V/1 k-ohms
Headphone Jack Rated Output/Impedance	
Output Level (8 ohms, 0.04% THD) .....	0.45V
Impedance .....	330 ohms
Frequency Response (20 Hz to 20 kHz)	
CD/TAPE/DVD-LD/TV-DBS/VCR	
.....	0±0.5 dB
RIAA Equalization Deviation	
PHONO MM .....	0±0.5 dB
Total Harmonic Distortion (20 Hz to 20 kHz)	
PHONO MM to REC OUT	
1V .....	0.02%
CD/TAPE/DVD-LD/TV-DBS/VCR to SP OUT	
30W/8 ohms .....	0.03%
Signal-to-Noise Ratio (IHF-A Network)	
PHONO MM to REC OUT	
(5 mV Input Shorted) .....	80 dB
CD/TAPE/DVD-LD/TV-DBS/VCR to SP OUT	
(Shorted) .....	93 dB
Residual Noise (IHF-A Network)	
MAIN L/R .....	140 µV
Channel Separation	
(Vol. -30 dB, EFFECT OFF)	
PHONO MM	
(Input Shorted, 1 kHz)	
.....	60 dB
CD/TAPE/DVD-LD/TV-DBS/VCR	
(Input 5.1 k-ohms Terminated,	
1 kHz) .....	60 dB

Tone Control Characteristics	
BASS: Boost/cut .....	±10 dB (50 Hz)
Turnover Frequency .....	(350 Hz)
TREBLE: Boost/cut .....	±10 dB (20 kHz)
Turnover Frequency .....	(3.5 kHz)

Gain Tracking Error (0 to -60 dB) .....3 dB

## VIDEO SECTION

Video Signal Type	
[U.S.A., Canada and General models]	
.....	NTSC/PAL
[Australia model] .....	PAL
Video Signal Level .....	1 Vp-p/75 ohms
Maximum Input Level .....	1.5 Vp-p or more
Signal-to-Noise Ratio .....	50 dB or more
Monitor Out Frequency Response	
.....	5 Hz to 10 MHz, -3 dB

## FM SECTION

Tuning Range	
[U.S.A. and Canada models]	
.....	87.5 to 107.9 MHz
[Australia and General models]	
.....	87.5 to 108.0 MHz
50 dB Quieting Sensitivity (IHF, 75 ohms)	
[U.S.A., Canada and General models only]	
Mono .....	1.55 µV (15.1 dBf)
Stereo .....	21 µV (37.7 dBf)
Usable Sensitivity	
DIN, Mono (S/N 26 dB)	
[Australia model] .....	0.9 µV
DIN, Stereo (S/N 46 dB)	
[Australia model] .....	24 µV
Image Response Ratio	
[U.S.A., Canada and General models]	
.....	45 dB
[Australia model] .....	80 dB
IF Response Ratio	
[U.S.A., Canada and General models]	
.....	70 dB
[Australia model] .....	80 dB
Spurious Response Ratio .....	70 dB
AM Suppression Ratio .....	55 dB
Capture Ratio .....	1.5 dB

Alternate Channel Selectivity  
[U.S.A., Canada and General models]  
.....85 dB

Selectivity (two signals, 40 kHz Dev.  $\pm$ 300 kHz)  
[Australia model] .....70 dB

Signal-to-Noise Ratio  
(IHF) Mono/Stereo  
[U.S.A., Canada and General models]  
.....80 dB/75 dB  
(DIN-Weighted, 40 kHz Dev.) Mono/Stereo  
[Australia models] .....75 dB/70 dB

Harmonic Distortion  
Mono/Stereo (1 kHz) .....0.1/0.2%

Stereo Separation (1 kHz) .....50 dB

Frequency Response  
20 Hz to 15 kHz .....0  $\pm$ 1.5 dB

## AM SECTION

Tuning Range  
[U.S.A., Canada and General models]  
.....530 to 1,710 kHz  
[Australia model] .....531 to 1,611 kHz

Usable Sensitivity .....100  $\mu$ V/m

Selectivity .....32 dB

Signal-to-Noise Ratio .....50 dB

Image Response Ratio .....40 dB

Spurious Response Ratio .....50 dB

Harmonic Distortion (1 kHz) .....0.3%

## AUDIO SECTION

Output Level/Impedance  
FM (100% mod., 1 kHz)  
[U.S.A., Canada and General models]  
.....500 mV/2.2 k-ohms  
[Australia model] .....400 mV/2.2 k-ohms  
AM (30% mod., 1 kHz)  
.....150 mV/2.2 k-ohms

## GENERAL

Power Supply  
[U.S.A. and Canada models]  
.....AC 120V, 60 Hz  
[Australia model] .....AC 240V, 50 Hz  
[General model]  
.....AC 110/120/220/240V, 50/60 Hz

Power Consumption  
<R-V702>  
[U.S.A. model] .....220W  
[Australia, Canada and General models]  
.....230W  
<R-V502>  
[U.S.A. model] .....190W  
[Canada model] .....210W  
[Australia and General models] .....200W

Maximum Power Consumption  
(8 ohms, 1 kHz, 10% THD, When 5 channels  
are driven:)

[General model only]  
<R-V702> .....540W  
<R-V502> .....430W

## AC Outlets

2 SWITCHED OUTLETS  
[U.S.A., Canada and General models]  
.....100W max. total  
1 SWITCHED OUTLET  
[Australia model] .....100W max. total

## Dimensions (W x H x D)

.....435 x 151 x 266.5 mm  
(17-1/8" x 5-15/16" x 10-1/2")

## Weight

<R-V702> .....8.7 kg (19 lbs. 2 oz.)  
<R-V502> .....7.8 kg (17 lbs. 3 oz.)

Accessories .....AM loop antenna  
Indoor FM antenna  
Remote control transmitter  
Batteries  
Antenna adapter  
(U.S.A. and Canada models only)

Specifications are subject to change without  
notice.

# YAMAHA

---

YAMAHA ELECTRONICS CORPORATION, USA 6660 ORANGETHORPE AVE., BUENA PARK, CALIF. 90620, U.S.A.  
YAMAHA CANADA MUSIC LTD. 135 MILNER AVE., SCARBOROUGH, ONTARIO M1S 3R1, CANADA  
YAMAHA ELECTRONIK EUROPA G.m.b.H. SIEMENSSTR. 22-34, 25462 RELINGEN BEI HAMBURG, F.R. OF GERMANY  
YAMAHA ELECTRONIQUE FRANCE S.A. RUE AMBROISE CROIZAT BP70 CROISSY-BEAUBOURG 77312 MARNE-LA-VALLEE CEDEX02, FRANCE  
YAMAHA ELECTRONICS (UK) LTD. YAMAHA HOUSE, 200 RICKMANSWORTH ROAD WATFORD, HERTS WD1 7JS, ENGLAND  
YAMAHA SCANDINAVIA A.B. J A WETTERGRENS GATA 1, BOX 30053, 400 43 VÄSTRA FRÖLUNDA, SWEDEN  
YAMAHA MUSIC AUSTRALIA PTY, LTD. 17-33 MARKET ST., SOUTH MELBOURNE, 3205 VIC., AUSTRALIA

YAMAHA CORPORATION

VV57220